

CREATE
YOUR STYLE
with SWAROVSKI ELEMENTS

DESIGN PROJECT

JUNIOR SPECIAL
CAT HAIR BAND



CAT HAIR BAND



SWAROVSKI ELEMENTS

Article	Product Group	Article No.	Amount	Size	Color	Color Code
	Sew-on Stones	3254	2 pcs.	20x9mm	Olivine	228

	Beads	5742	1 pc.	8mm	Siam	208
---	-------	------	-------	-----	------	-----

Supplies & Tools

- Supplies**
- 10x20cm Cotton, pink-white
 - Dacron, white
 - 0.5 m Embroidery thread, green
 - 1.5 m Embroidery thread, white
 - 1 Hair band, violet
 - 1 m Nylon thread, transparent, Ø 0.15 mm
 - Sewing silk, white

- Tools**
- Double sided sticky tape
 - Embroidery needle
 - Needle
 - Pins
 - Scissors
 - Sewing machine
 - 1 Sheet of paper, DIN A4
 - Tweezers

Level of design: BEGINNER

Have also a look at the **text instruction** at the last page!

STEP 1

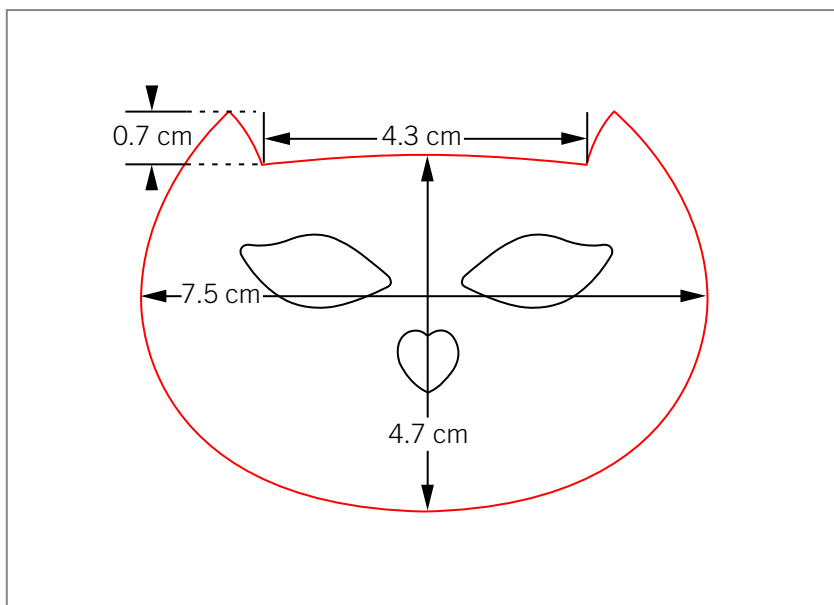

STEP 2

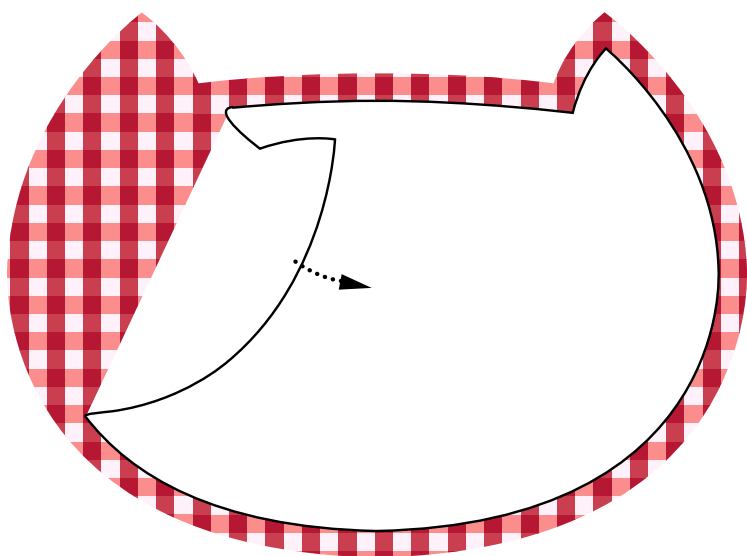
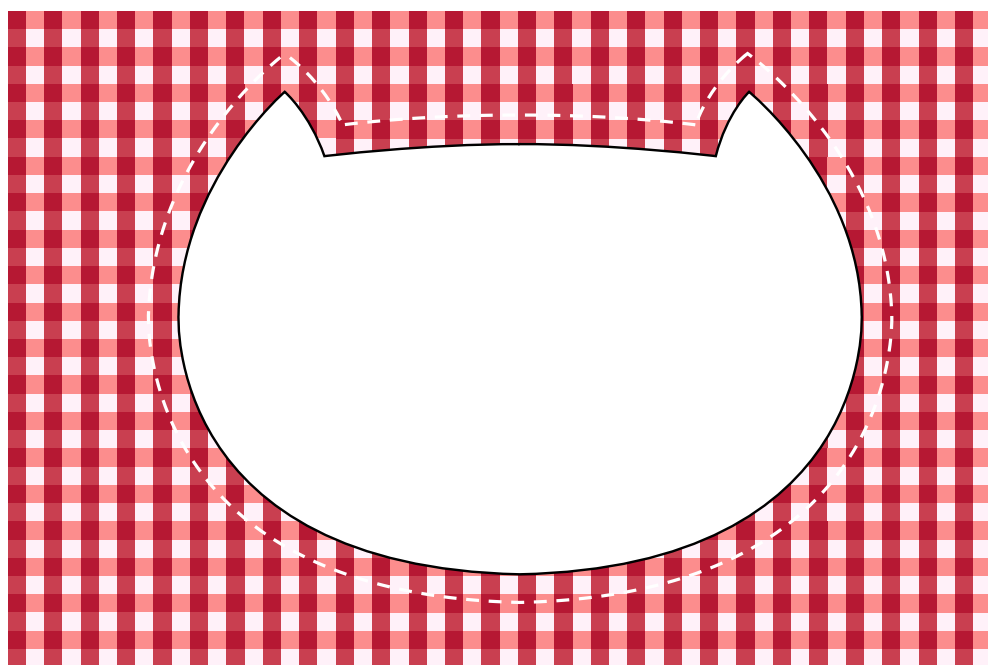
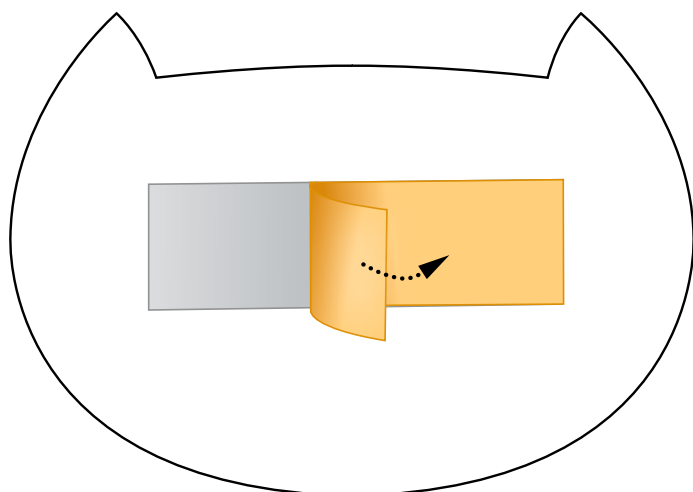

STEP 3

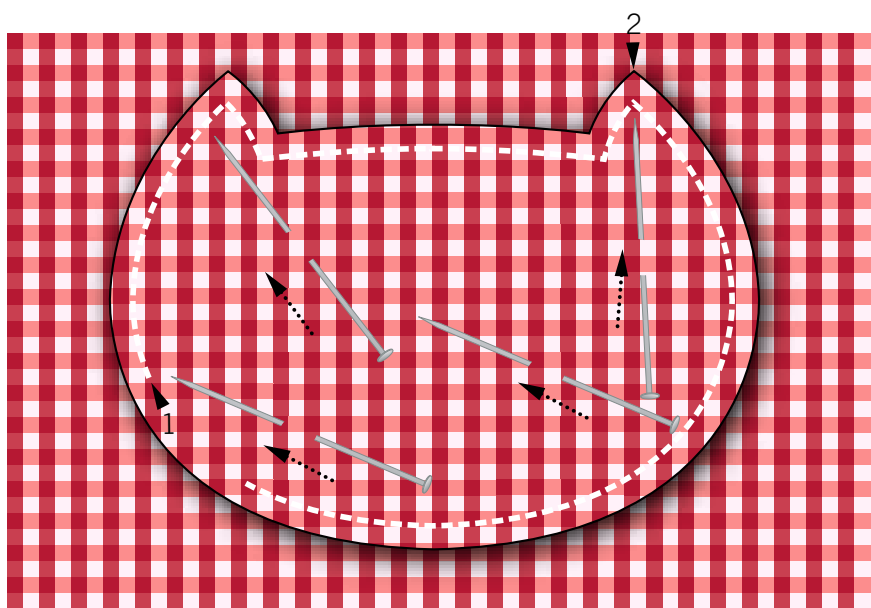

1



2

STEP 4

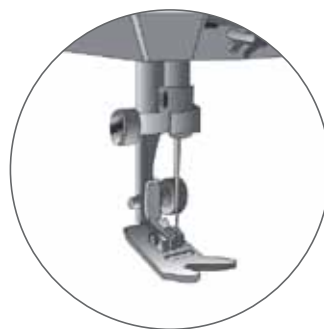
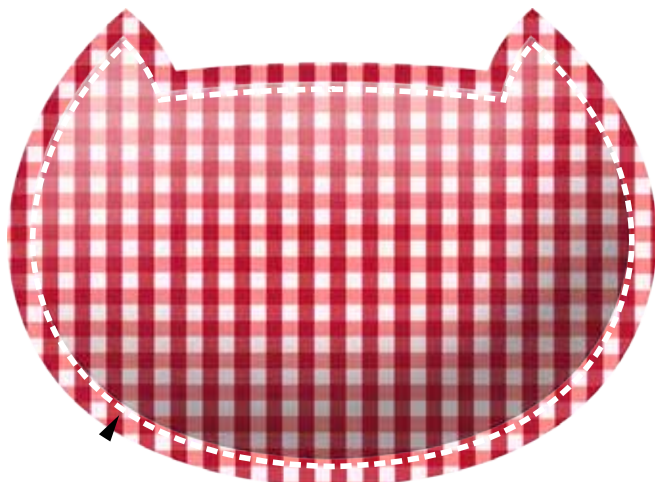
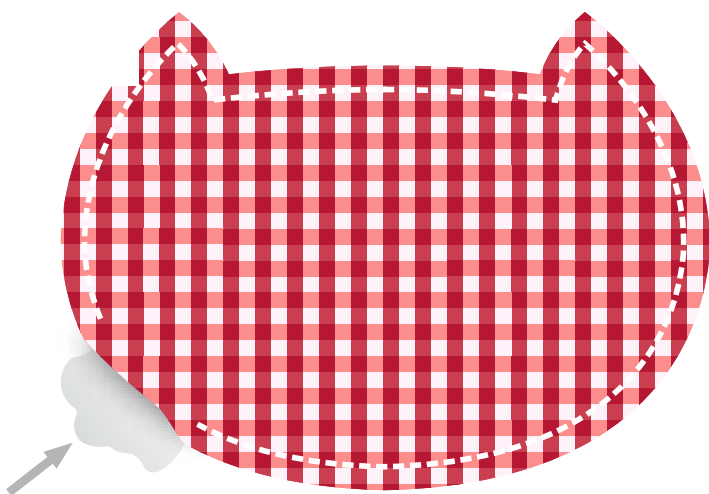

STEP 5

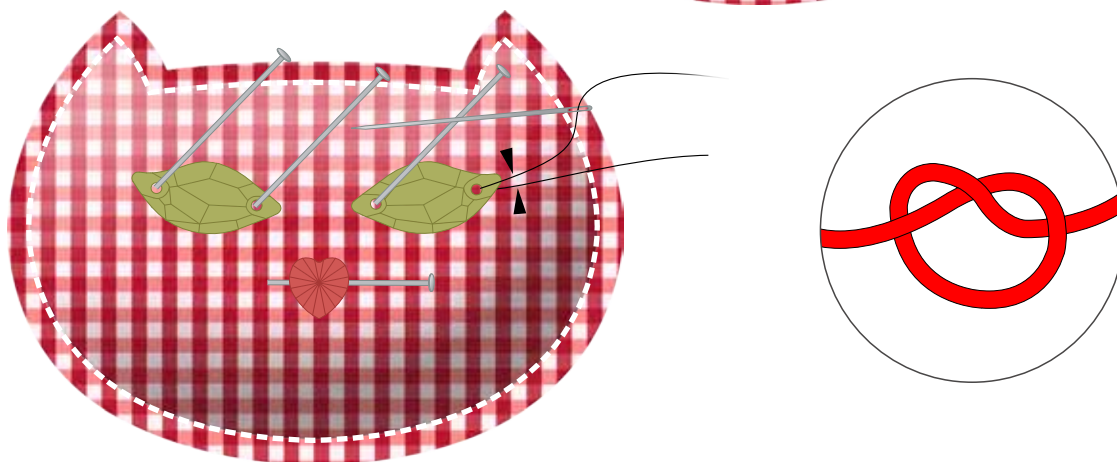
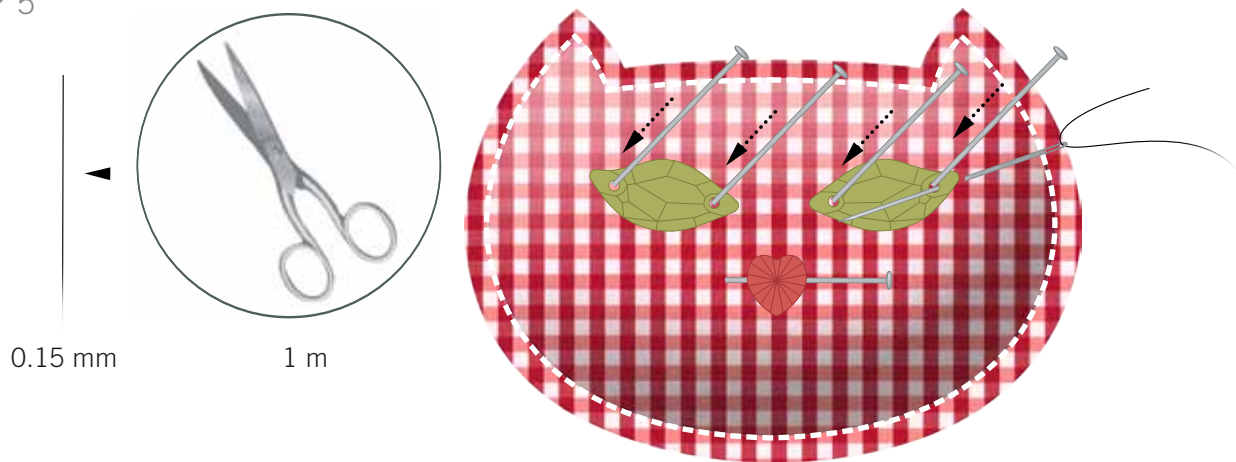

STEP 6

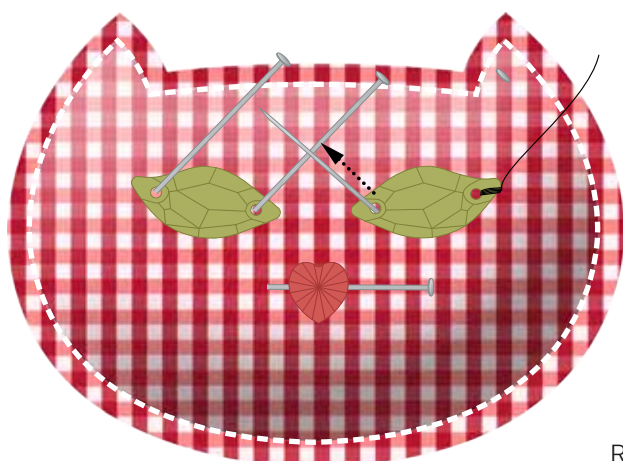
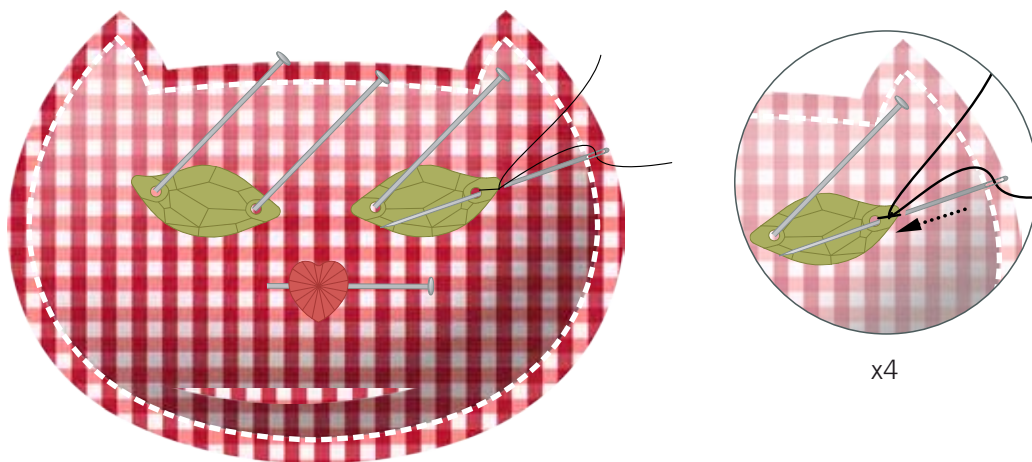

Repeat step

STEP 7

Repeat steps 6 x2:

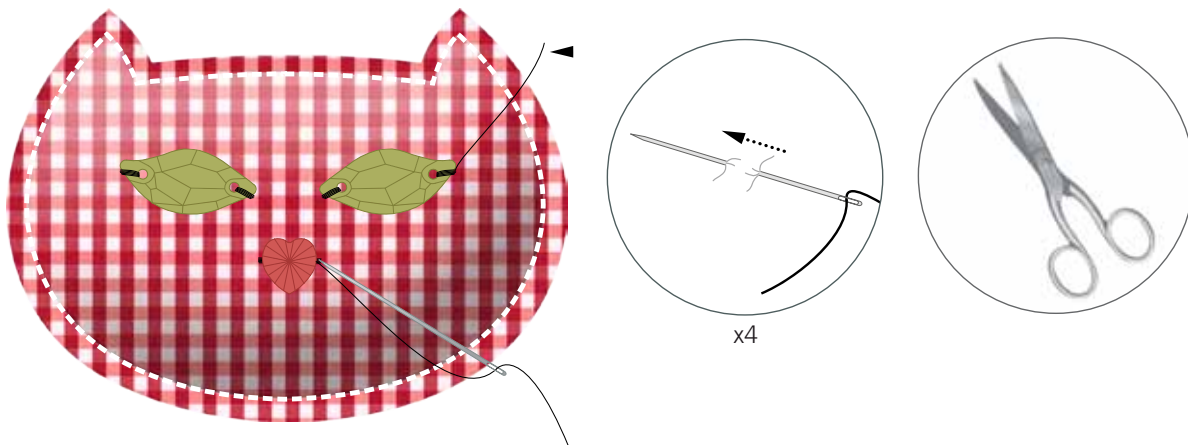

STEP 8

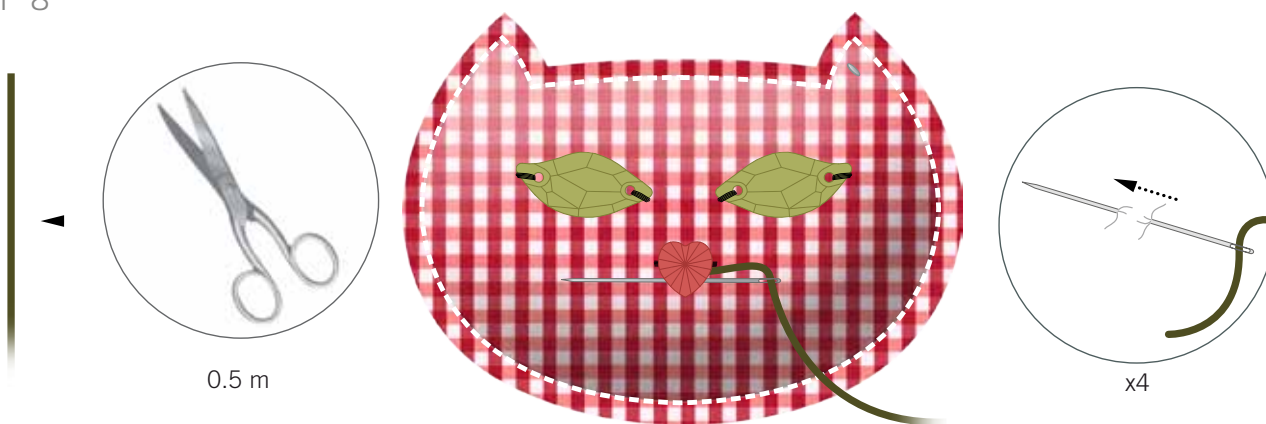

STEP 9

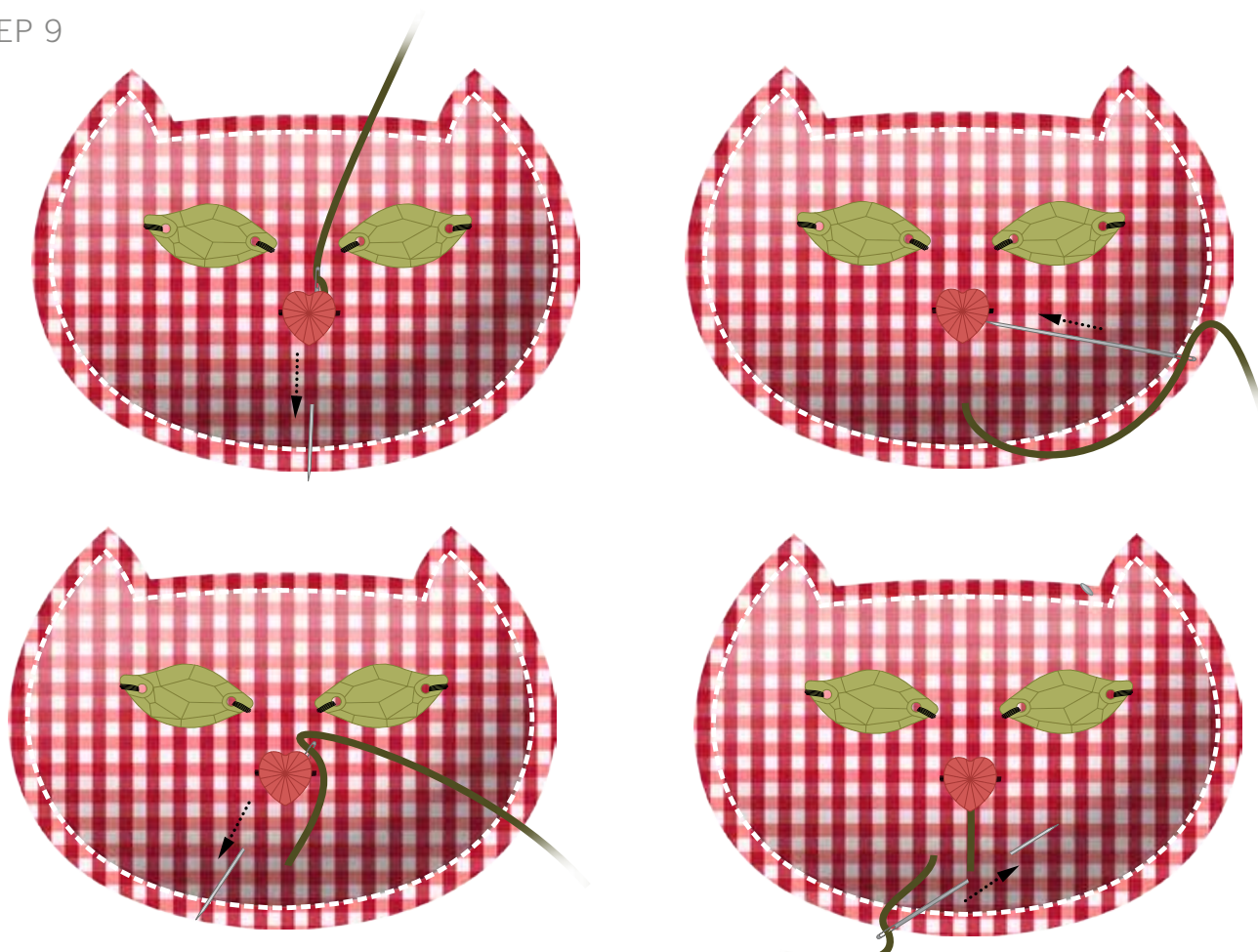

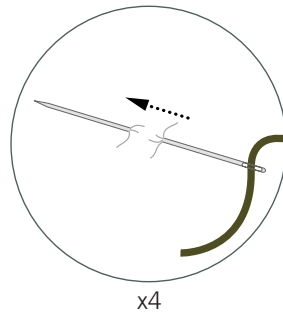
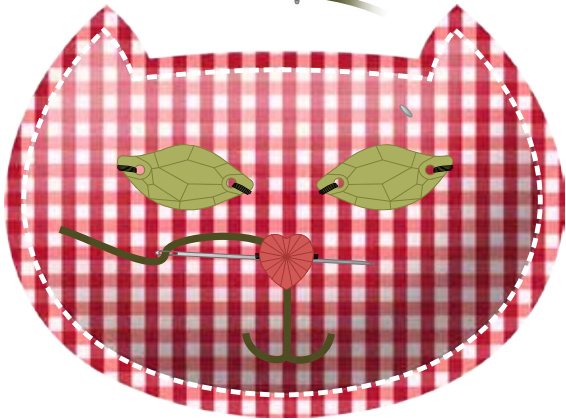

x4

STEP 10

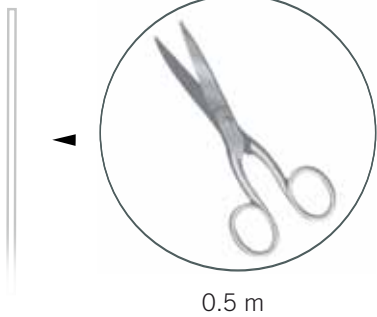

0.5 m

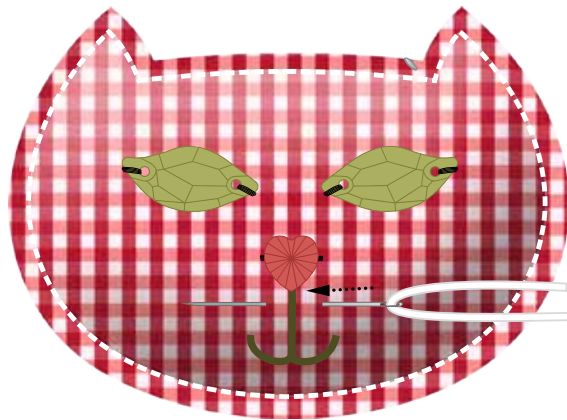

Repeat x2



STEP 11

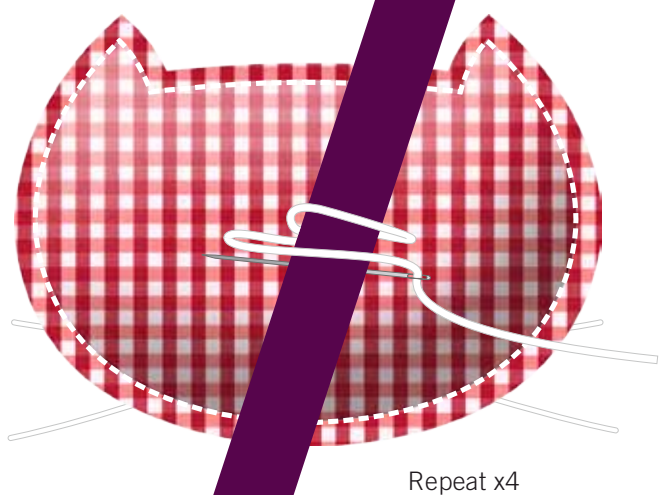
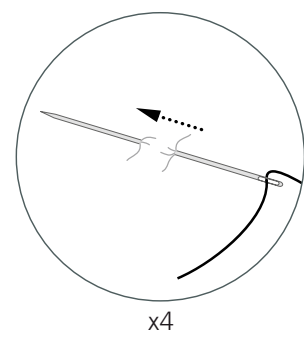
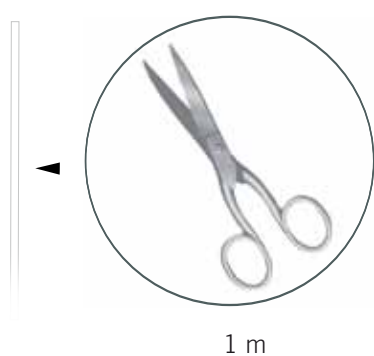

STEP 12

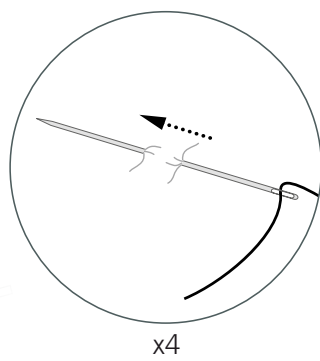
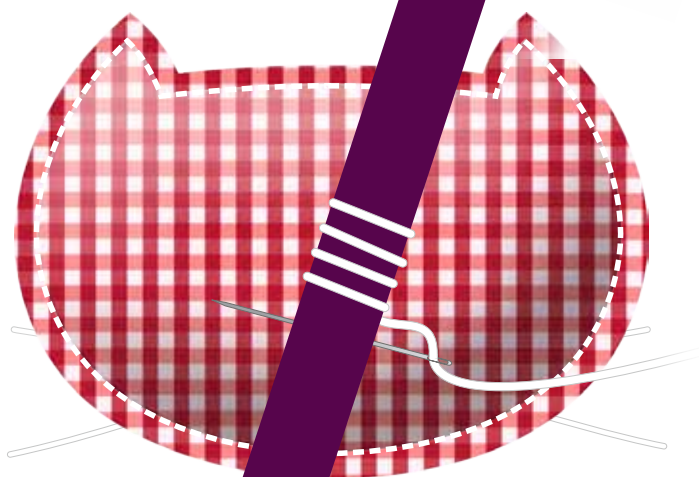

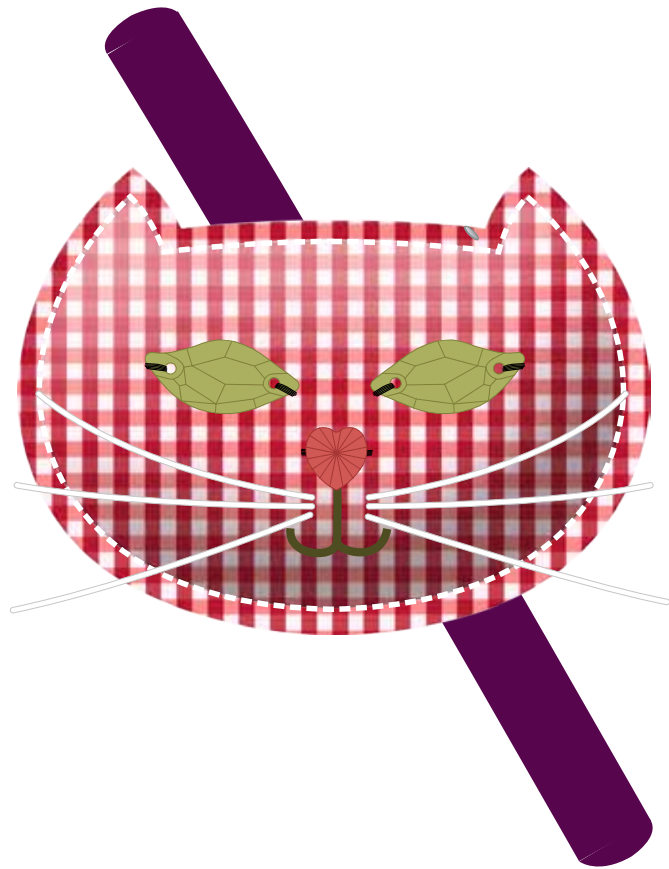

CREATE YOUR STYLE with SWAROVSKI ELEMENTS Design Project

Junior Special: Cat Hair Band

- STEP 1: Print pattern out and cut out cat's head along red outline.
- STEP 2: Stick pattern with some double sided sticky tape onto the cotton fabric and cut out making the pattern 3 mm bigger than pattern out line (as white dotted line shows in illustration). Remove pattern from fabric.
- STEP 3: Lay the first cut out onto another piece of cotton fabric and cut out the second fabric piece. Attach the two pieces with pins and sew them together with a sewing machine using the white sewing silk. Leave a small space that is not sewn as you see in illustration.
- STEP 4: Fill the head with some Dacron using tweezers. Sew the opening closed and cut off threads.
- STEP 5: Cut 1 m of 0.15 mm nylon thread. Attach the Swarovski Sew-on Stones with some pins onto cat's head as you see in pattern. Sew the nylon thread once through fabric and the through the first hole of Sew-on Stone and knot both nylon thread ends afterwards.
- STEP 6: Sew through the same hole four times, then stitch to next hole and repeat to attach the first Swarovski Sew-on Stone.
- STEP 7: Repeat step 6 twice to attach second Sew-on Stone and Swarovski Heart Bead. Make 4 back stitches to attach the nylon thread and cut off both thread ends.
- STEP 8: Cut 0.5 m of green embroidery thread and fix thread with 4 back stitches which are hidden under Swarovski Heart Bead.
- STEP 9: Embroider as you see in illustration and attach the thread at the end with some back stitches and cut off thread ends.
- STEP 10: Cut 0.5 m of white embroidery thread and make a stitch to form whiskers. Cut off thread after stitch and repeat to get three whiskers on each side.
- STEP 11: Cut 1 m of white embroidery thread and fix thread with 4 back stitches on back side of cat's head and wrap thread five times around headband.
- STEP 12: Finish with 4 back stitches as you see in the illustration and cut off remaining thread.