

CREATE
YOUR STYLE
with SWAROVSKI ELEMENTS



MAKE YOUR CREATIVITY STICK

















DIARY
BEING INTIMATE

DIARY BEING INTIMATE



SWAROVSKI ELEMENTS

Supplies & Tools

Article	Product Group	Article No.	Amount	Size	Color	Color Code
	Flat Backs No Hotfix	2493	4 pcs.	10 mm	Crystal	001
	Flat Backs No Hotfix	2520	3 pcs.	8x6 mm	Crystal Golden Shadow	001 GSHA
	Flat Backs No Hotfix	2709	3 pcs.	18x13 mm	Crystal Golden Shadow	001 GSHA
	Flat Backs No Hotfix	2709	2 pcs.	18x13 mm	Crystal Silver Shade	001 SSHA
	Fancy Stones	4854	6 pcs.	8 mm	Crystal	001
	Beads	5000	3 pcs.	6 mm	Crystal	001
	Beads	5000	3 pcs.	6 mm	Crystal Silver Shade	001 SSHA
	Beads	5000	4 pcs.	6 mm	Rose Water Opal	395
	Pearls	5810	3 pcs.	4 mm	Crystal Mauve Pearl	001 160
	Pearls	5810	7 pcs.	4 mm	Crystal Powder Rose Pearl	001 352
	Pearls	5810	6 pcs.	6 mm	Crystal Bronze Pearl	001 295
	Pearls	5810	5 pcs.	6 mm	Crystal Mauve Pearl	001 160
	Pearls	5810	1 pc.	8 mm	Crystal Powder Rose Pearl	001 352
	Pendants	6723	1 pc.	28 mm	Crystal	001
	Crystal-it		18 pcs.	2 mm	Crystal Dorado	001 DOR
	Crystal-it		13 pcs.	3 mm	Crystal Dorado	001 DOR

Supplies

Cardboard, 180x720 mm
Crimping tube, silver, 1 mm
Elastic string, black, Ø 0.5 mm, 36 cm
Nylon thread, 1.15 mm
Pile of paper

Tools

Crimping pliers
Glue
Puncher
Scissors
Tweezer

Level of Design: **ADVANCED**

Have a look at the **text instruction** at the last page!

STEP 1

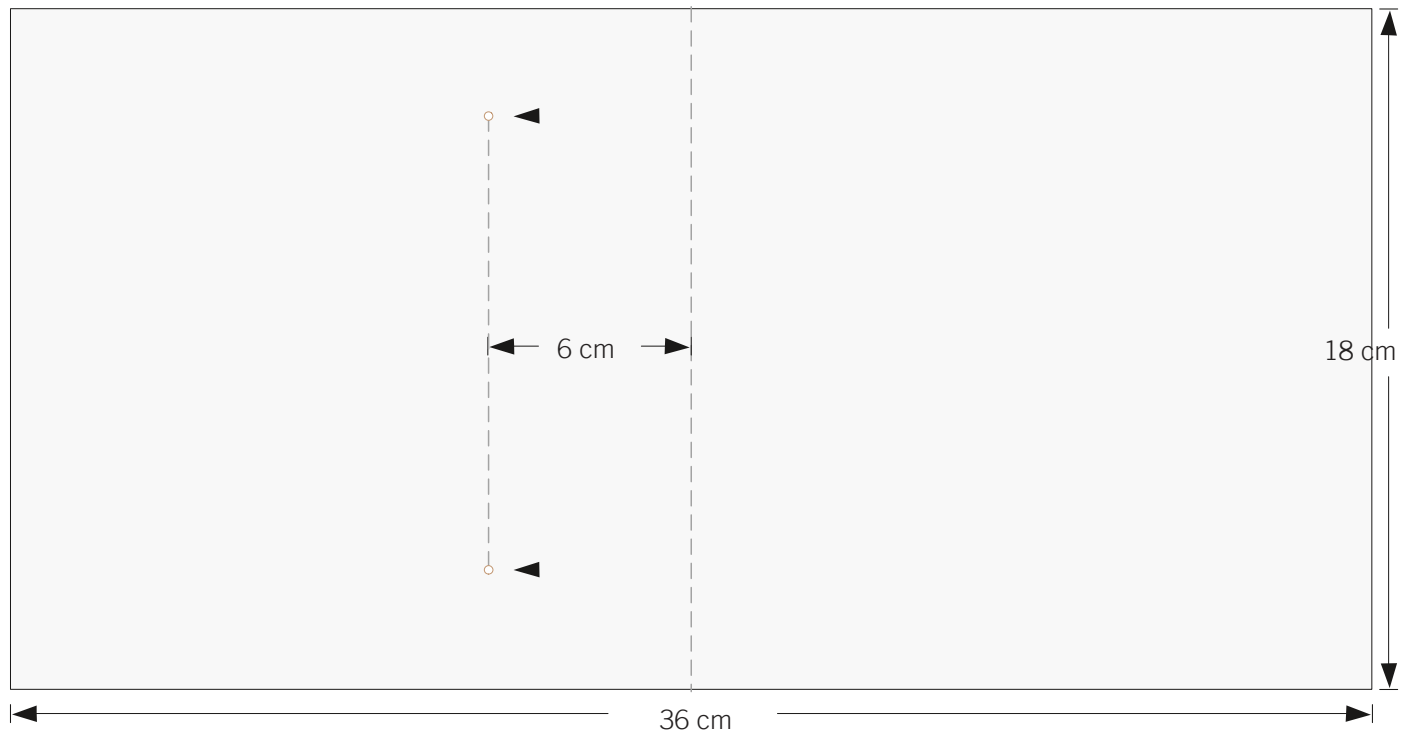

A



1 : 2

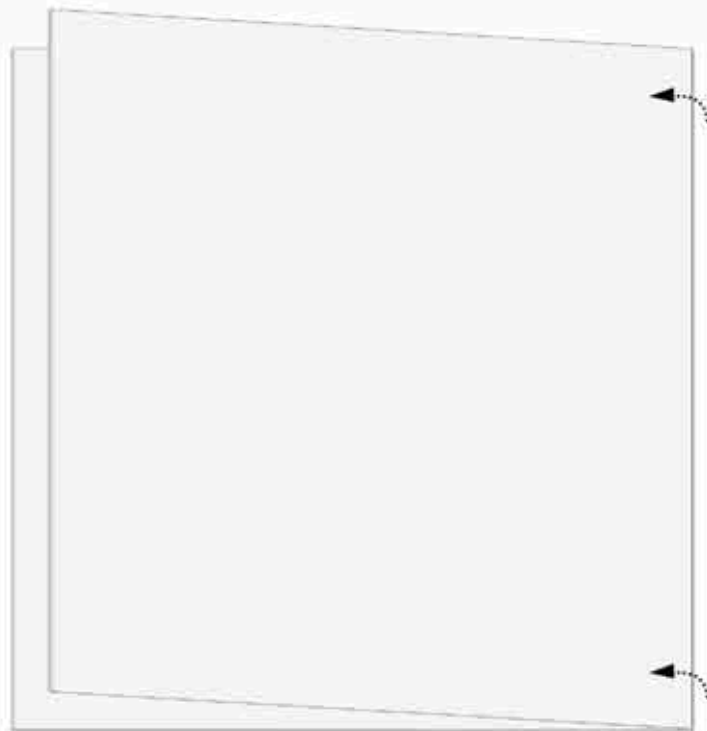

A

STEP 2

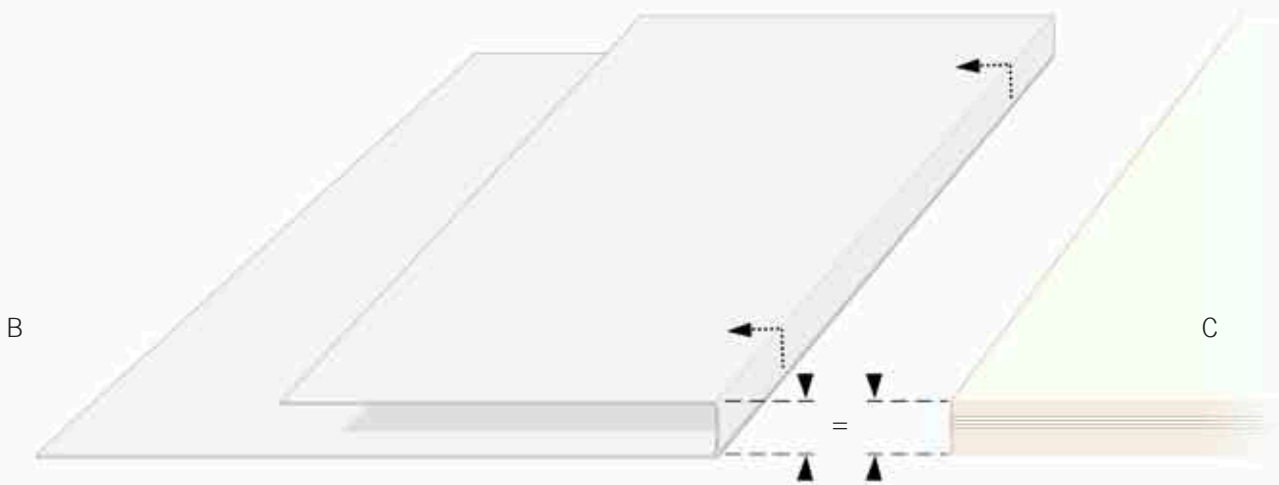
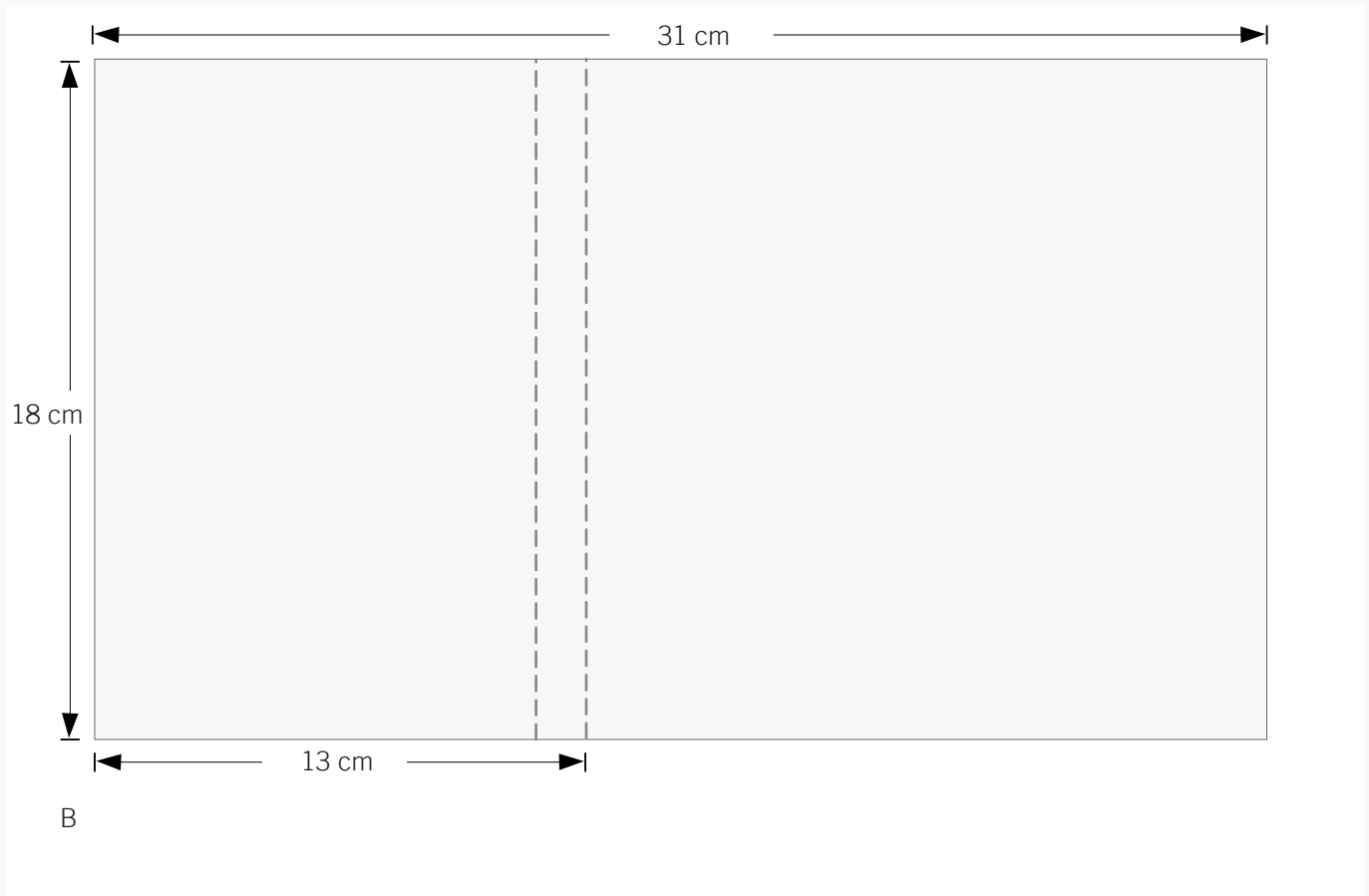

STEP 3

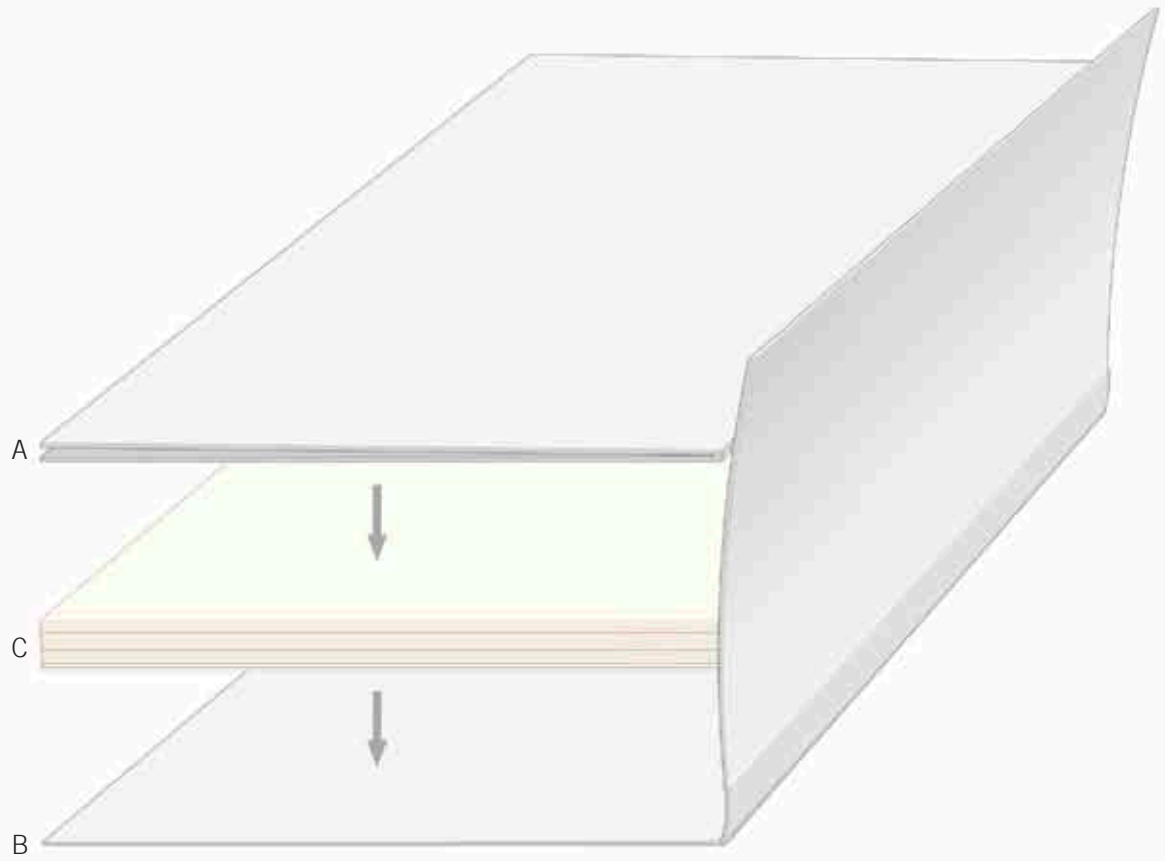

STEP 4

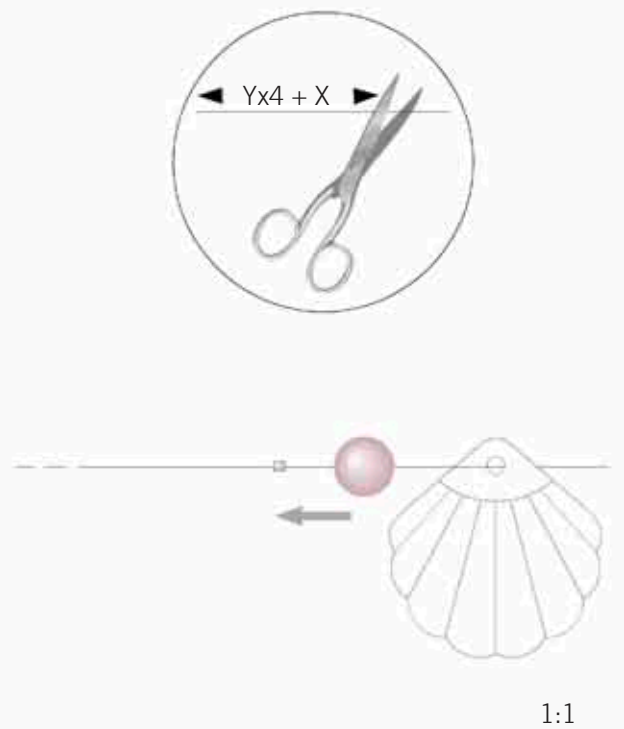
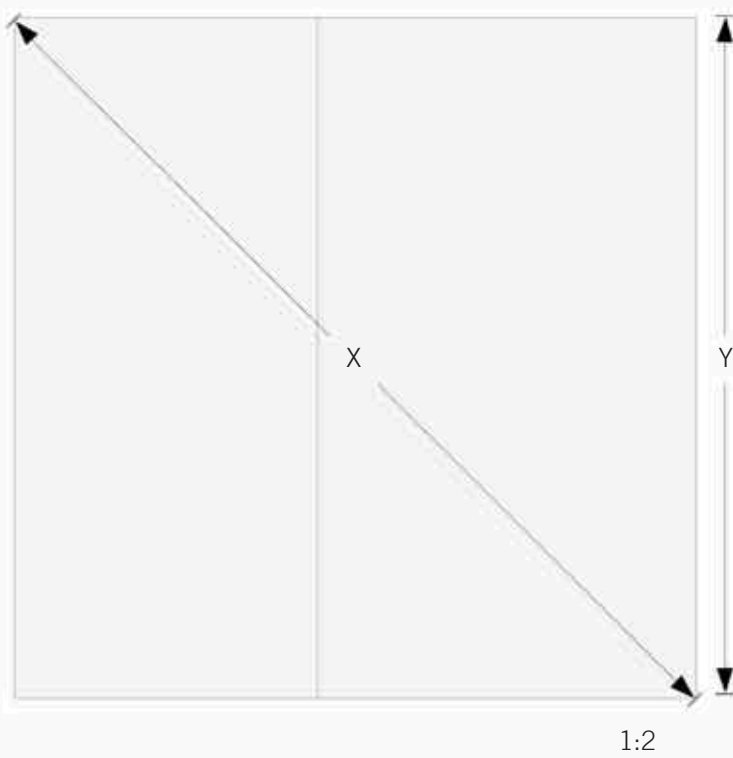

STEP 5

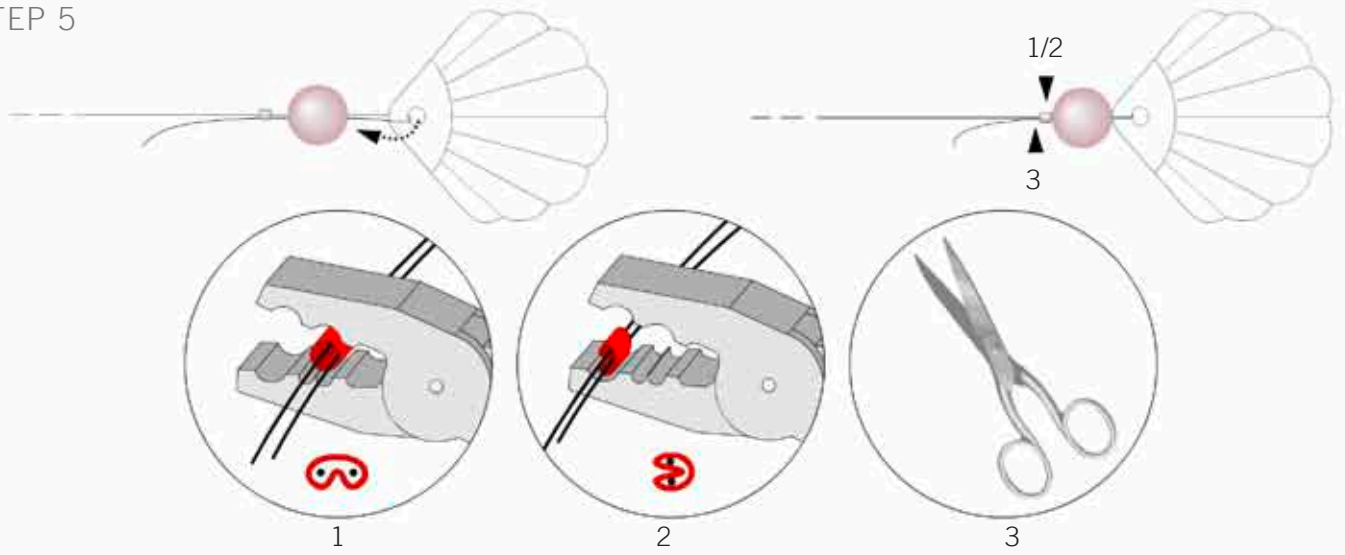

STEP 6

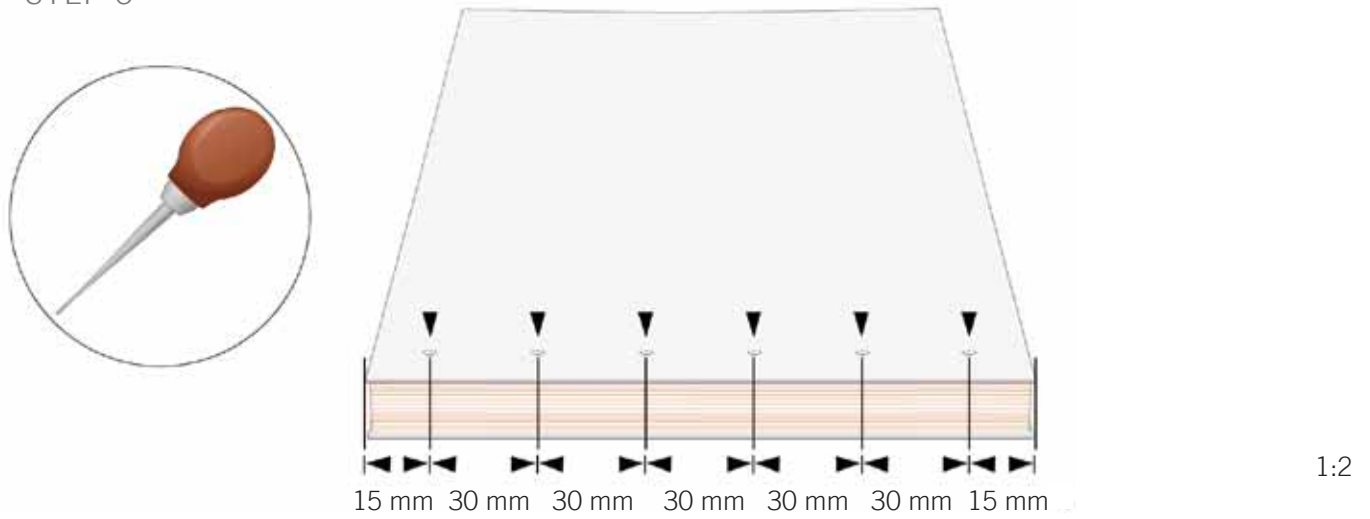

STEP 7

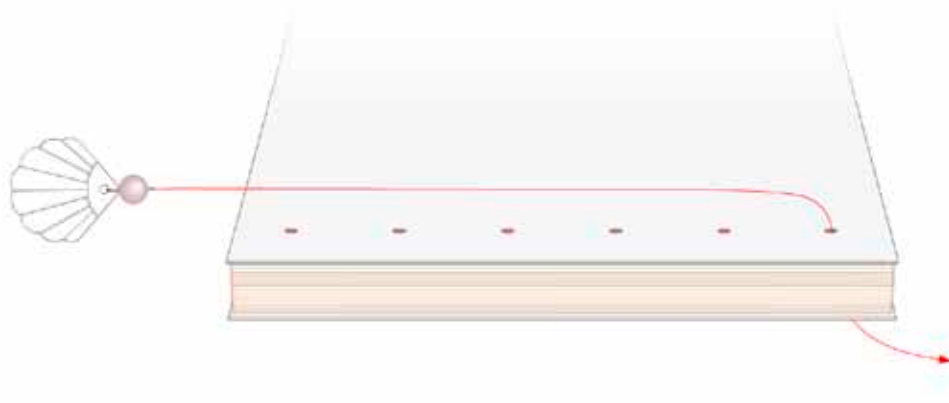

STEP 8

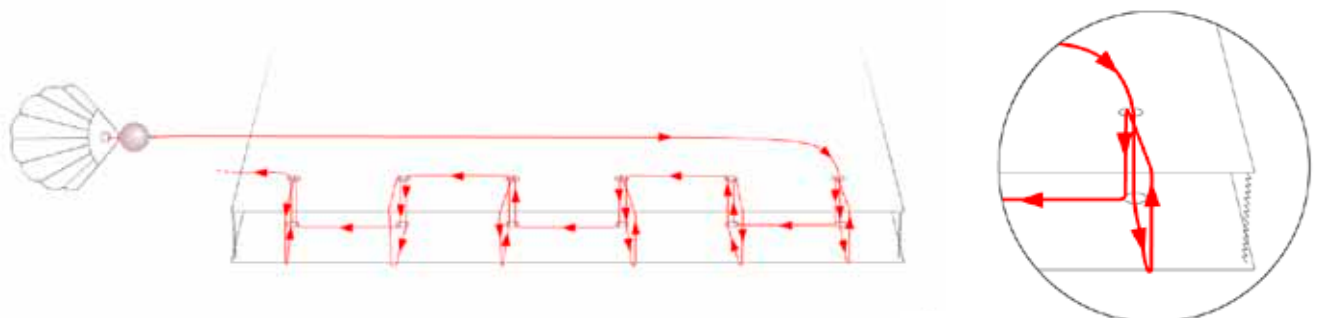

STEP 9

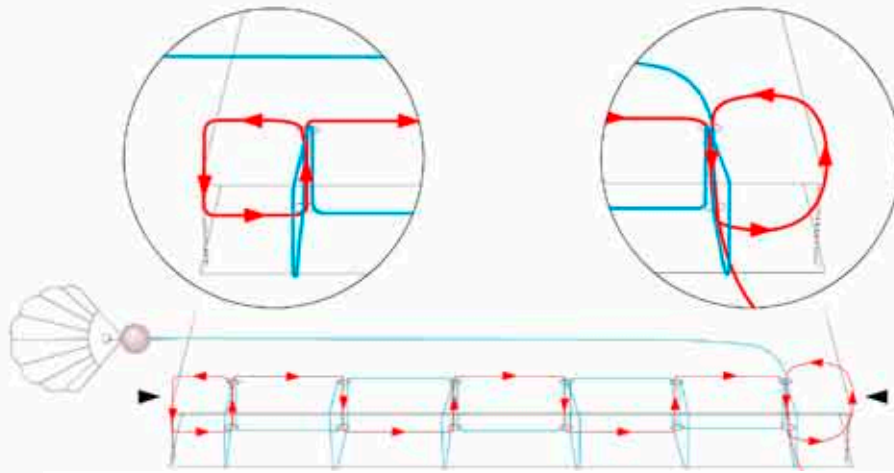

STEP 10

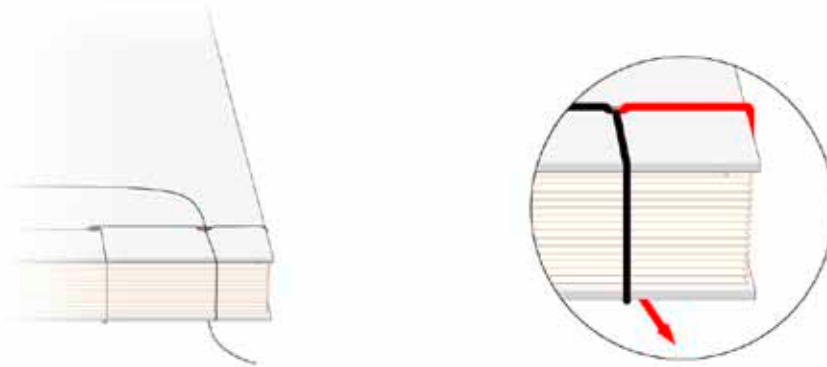

STEP 11



STEP 12



STEP 13

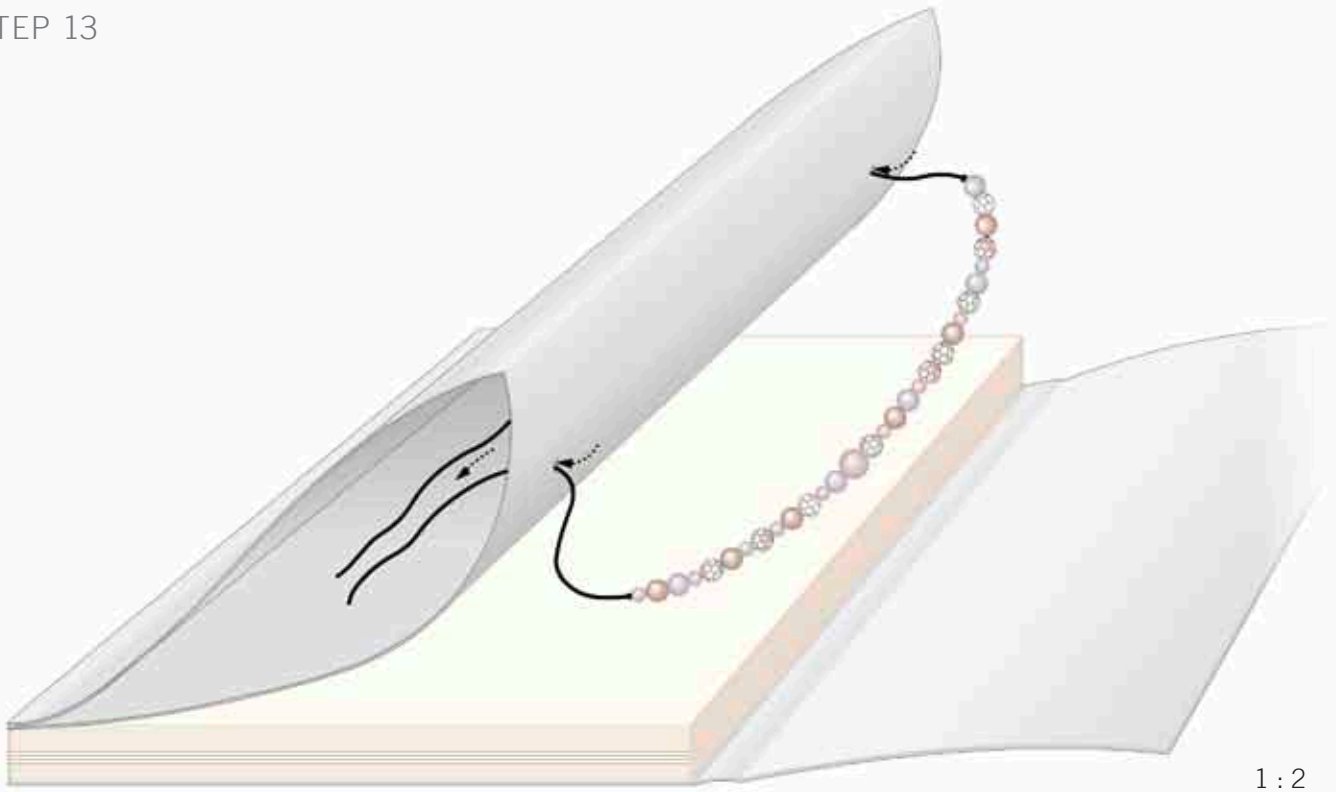

1 : 2

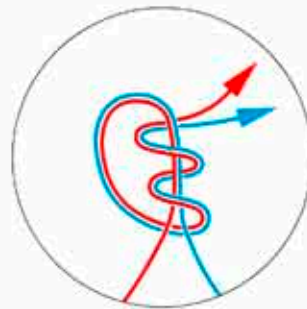
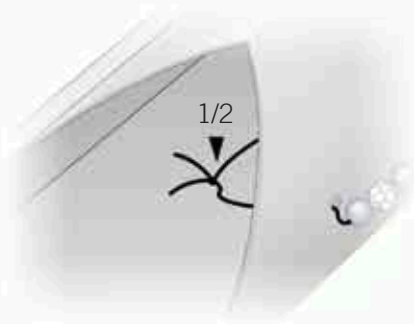

1



2

STEP 14



STEP 15

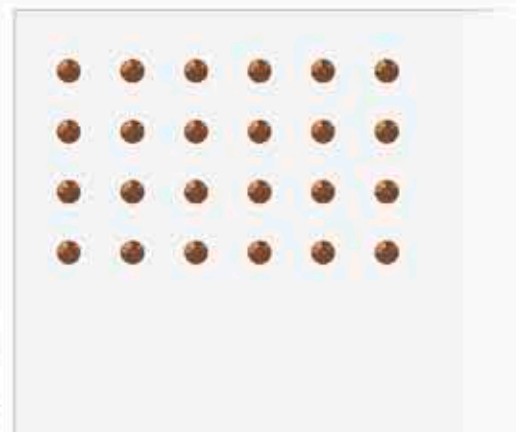
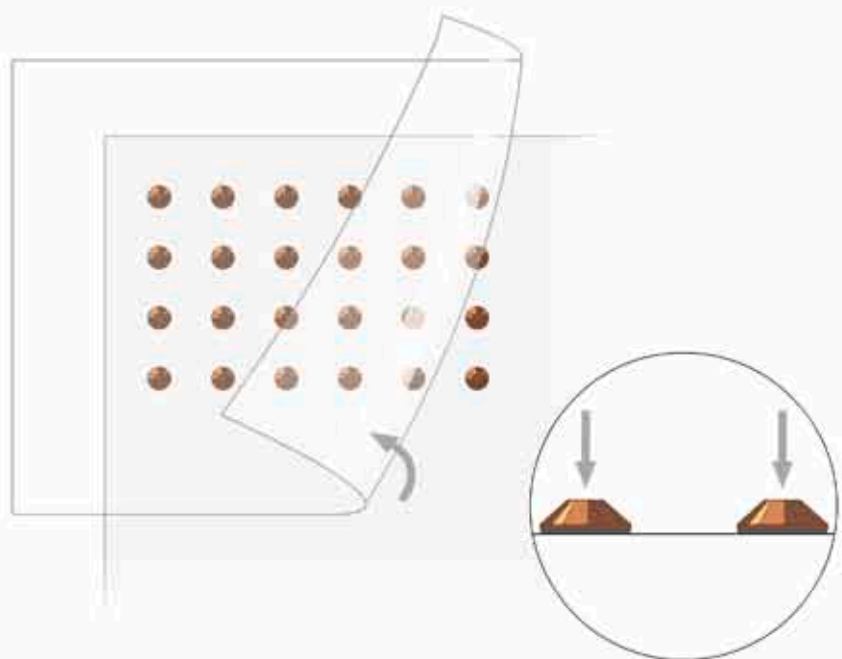
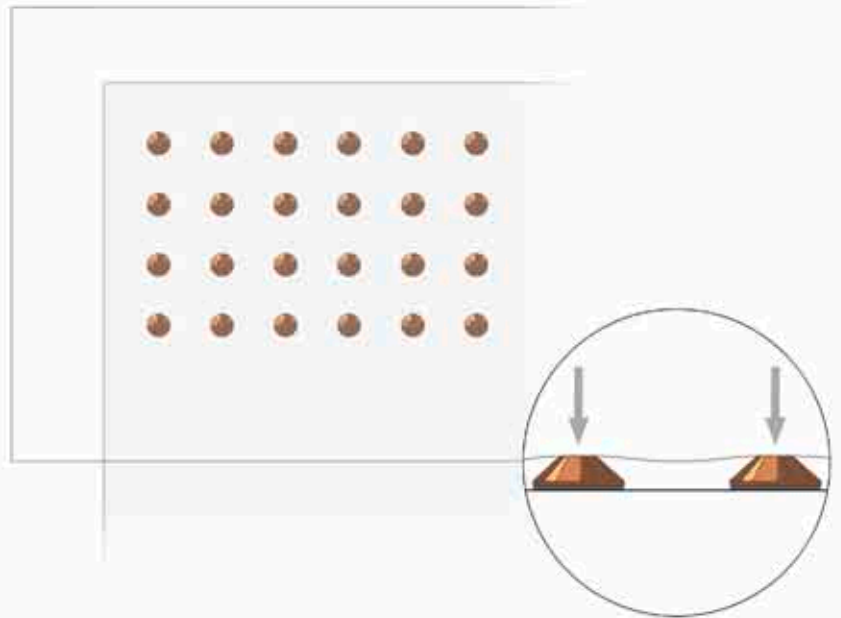
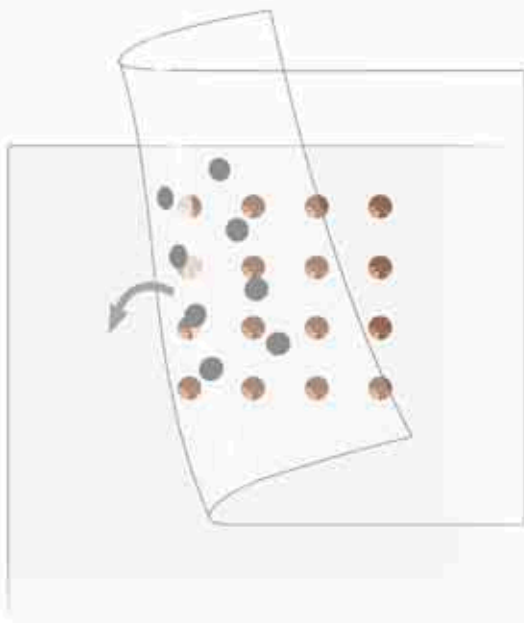
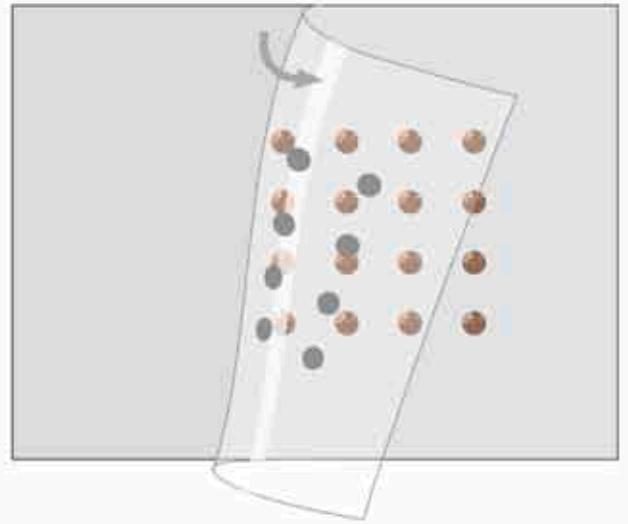

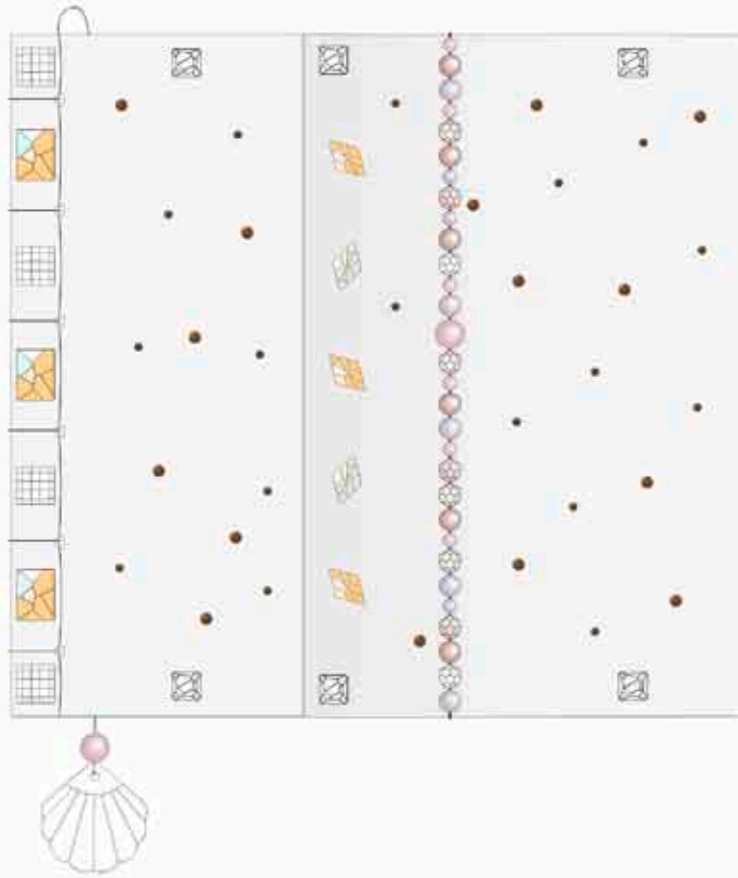

1:2

CREATE YOUR STYLE with SWAROVSKI ELEMENTS Design Project

Diary Being Intimate

- Step 1: Cut the cardboard to the dimensions as indicated in the illustration in Step 1. Punch two holes into it as shown in the illustration and fold the cardboard in half.
- Step 2: Cut a second piece out of the cardboard to the dimensions as shown in the illustration in step 2. Fold the book cover as per the measurements shown in the illustration.
- Step 3: Now place all three of them in a stack as shown in the illustration. The book cover (B), the pile of paper (C) and the cardboard on the top of the cover (A).
- Step 4: Cut a nylon thread into a length 4 times the height of the book (as denoted as y) and one time the length of the diagonal proportion of the book (as denoted by X). So the total length would be $y \times 4 + X$. Slide a crimping tube, a Swarovski Crystal Pearl article 5810 4 mm Crystal Powder Rose Pearl and a Swarovski Pendant article 6723 Crystal on to the nylon thread.
- Step 5: As shown in the illustration, slide the thread back through the pearl and the crimping tube, now crimp the tube and cut off the leftover thread from this short end.
- Step 6: Turn the book in a way that the book cover is up and make 6 holes into the stack as shown in the illustration.
- Step 7: String the nylon thread through the first hole of the book as shown in the illustration.
- Step 8: Move the nylon thread as shown in the illustration until you reach the other end.
- Step 9: Thread a loop back in a right angle and move towards the starting point as shown in the illustration. At the end make a loop back in a right angle.
- Step 10: Put some glue on the nylon thread, pull it tight and let it dry.
- Step 11: Cut an elastic string 36 cm in length. Using a beading needle slide on the following Swarovski Beads and Crystal Pearls:
 - 1x 5810 4 mm Crystal Powder Rose Pearl
 - 1x 5810 6 mm Crystal Bronze Pearl
 - 1x 5810 6 mm Crystal Mauve Pearl
 - 1x 5810 4 mm Crystal Powder Rose Pearl
 - 1x 5000 6 mm Crystal Silver Shade
 - 1x 5810 6 mm Crystal Bronze Pearl
 - 1x 5810 4 mm Crystal Mauve Pearl
 - 1x 5000 6 mm Rose Water Opal
 - 1x 5810 4 mm Crystal Mauve Pearl
 - 1x 5810 6 mm Crystal Bronze Pearl
 - 1x 5000 6 mm Crystal
 - 1x 5810 4 mm Crystal Powder Rose Pearl
 - 1x 5810 6 mm Crystal Mauve Pearl
 - 1x 5810 8 mm Crystal Powder Rose Pearl
 - 1x 5000 6 mm Crystal Silver Shade
 - 1x 5810 4 mm Crystal Powder Rose Pearl
 - 1x 5810 6 mm Crystal Bronze Pearl
 - 1x 5810 6 mm Crystal Mauve Pearl
 - 1x 5810 4 mm Crystal Powder Rose Pearl
 - 1x 5000 6 mm Rose Water Opal
 - 1x 5000 6 mm Crystal Silver Shade
 - 1x 5810 6 mm Crystal Bronze Pearl
 - 1x 5810 4 mm Crystal Powder Rose Pearl
 - 1x 5000 6 mm Crystal Silver Shade
 - 1x 5810 6 mm Crystal Mauve Pearl

CREATE YOUR STYLE with SWAROVSKI ELEMENTS Design Project Diary Being Intimate

1x 5810 4 mm Crystal Mauve Pearl
1x 5000 6 mm Rose Water Opal
1x 5810 6 mm Crystal Bronze Pearl
1x 5000 6 mm Crystal
1x 5000 6 mm Crystal Mauve Pearl

Step 12: Make a single knot after the first and the last Crystal Pearls.

Step 13: As shown in the illustration string the thread through the two holes that were made in step 1 and make a double knot with the beginning and the ending of the thread. Put some glue on to the knot and pull the knot inwards.

Step 14: Put a bit of glue on the cardboard where you will place the Swarovski Flat Back articles, 2439 & articles 2709 as shown in the illustration (The last picture in illustrations show where to place these elements). Set the crystal with the help of the tweezers.

Step 15: Apply the rest of the Swarovski Crystal-its with tweezers.