

CREATE
YOUR STYLE with
CRYSTALLIZED™
-Swarovski Elements

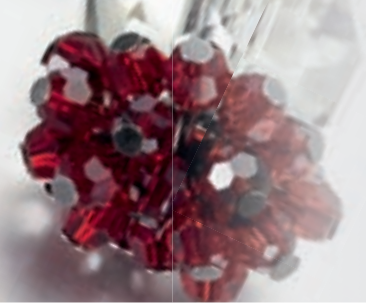



INSPIRATION BOOK INSTRUCTION
FLOWER
PENDANT

FLOWER PENDANT



CRYSTALLIZED™ – Swarovski Elements

| Article | Product Group | Article No. | Amount | Size | Colour | Colour Code |
|---|---------------|-------------|---------|-------|----------------------|-------------|
|  | Beads | 5000 | 26 pcs. | 4 mm | Siam | 227 |
|  | Beads | 5041 | 1 pc. | 18 mm | Crystal Silver Shade | 001 SSHA |

Supplies & Tools

Supplies
 26x, Headpins, black, 0.7x45 mm
 1x, Jumping, silver, Ø 3.8 mm, 0.8 mm
 Leather cord, black, Ø 2 mm, 100 cm
 Wire, black, Ø 0.7 mm, 20 cm

Tools
 Flat nose pliers
 Round nose pliers
 Steel stick, Ø 4 mm
 Tweezers
 Wire cutter

Level of design: INTERMEDIATE

Have also a look at the **text instruction** at the last page!

STEP 1

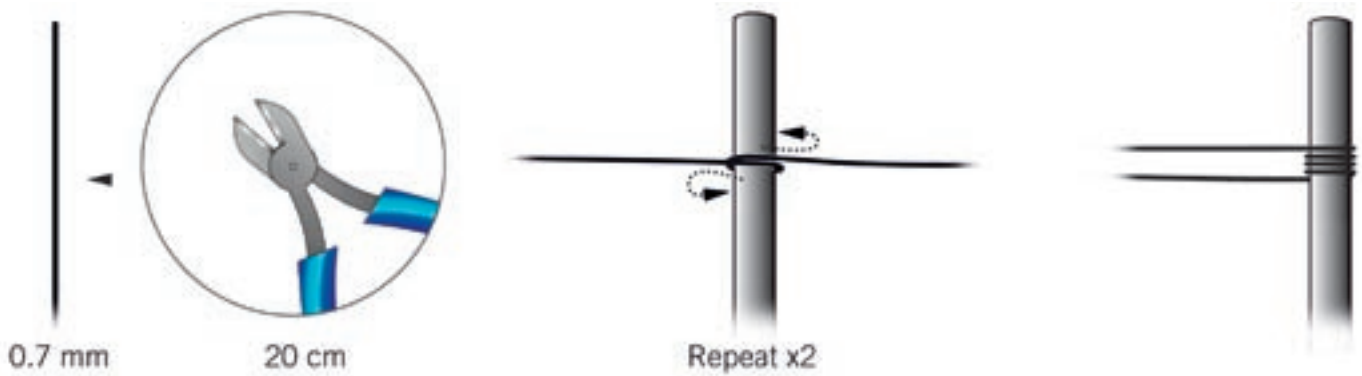

STEP 2



STEP 3



STEP 4

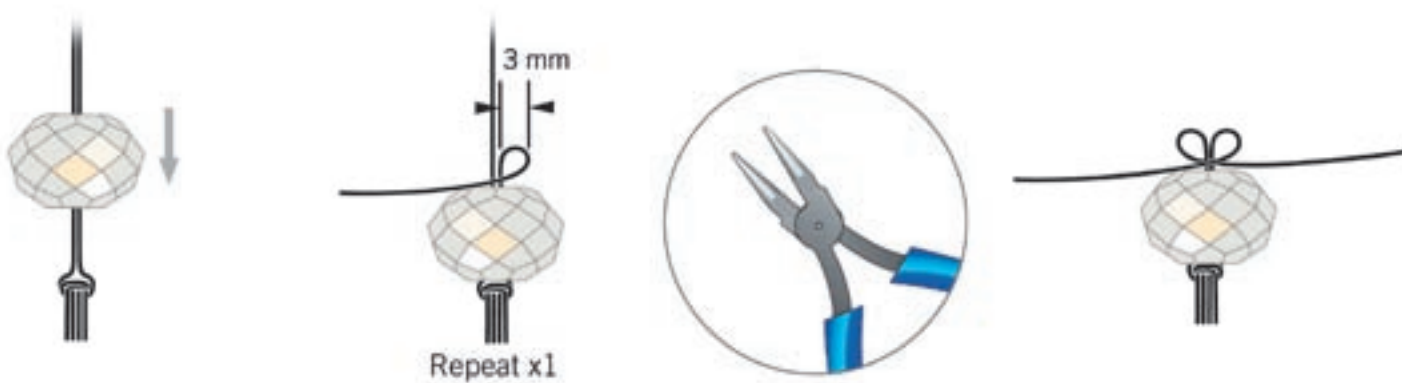

STEP 5

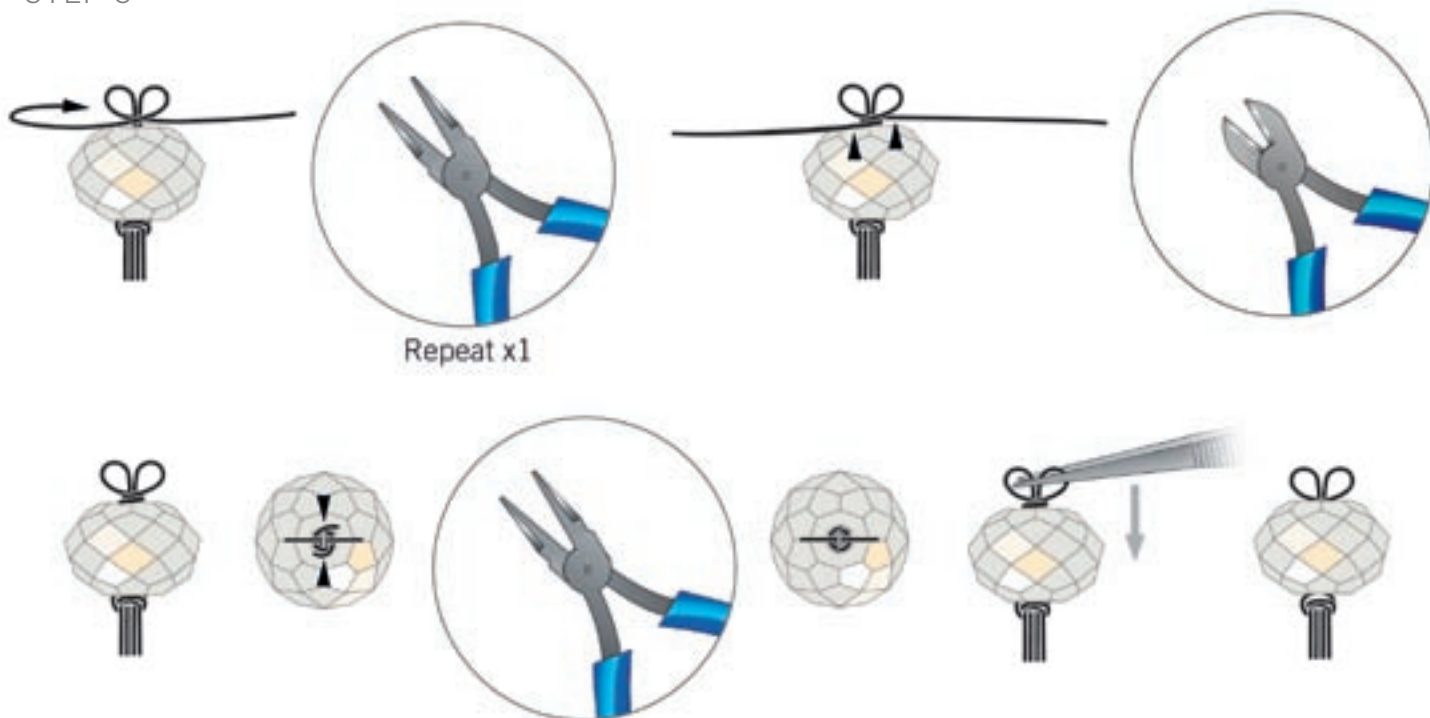

STEP 6

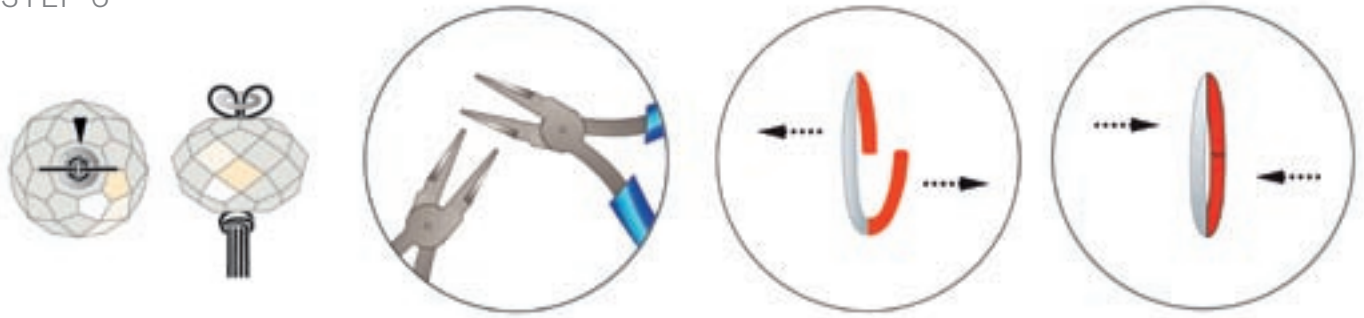

STEP 7

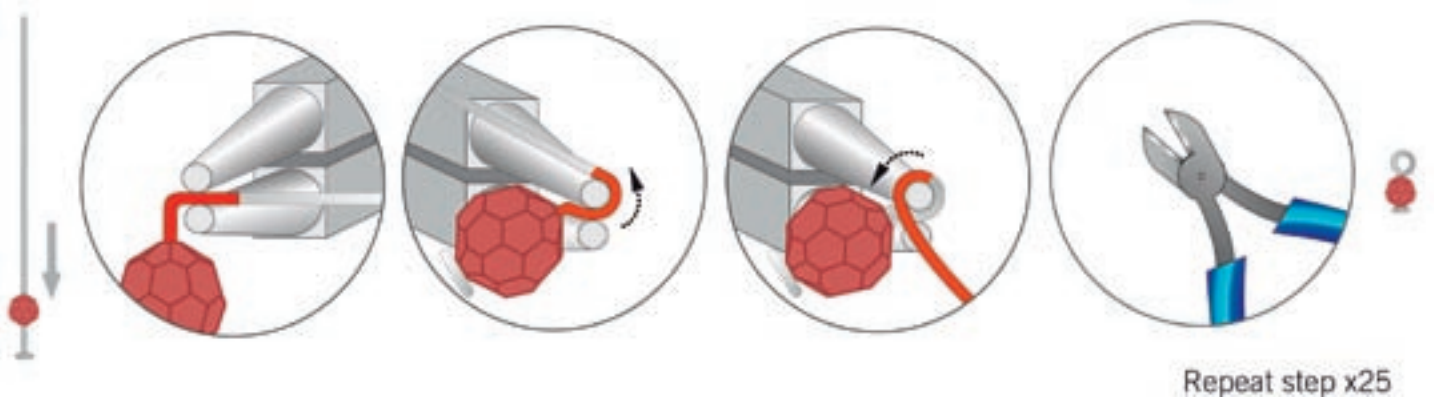

STEP 8

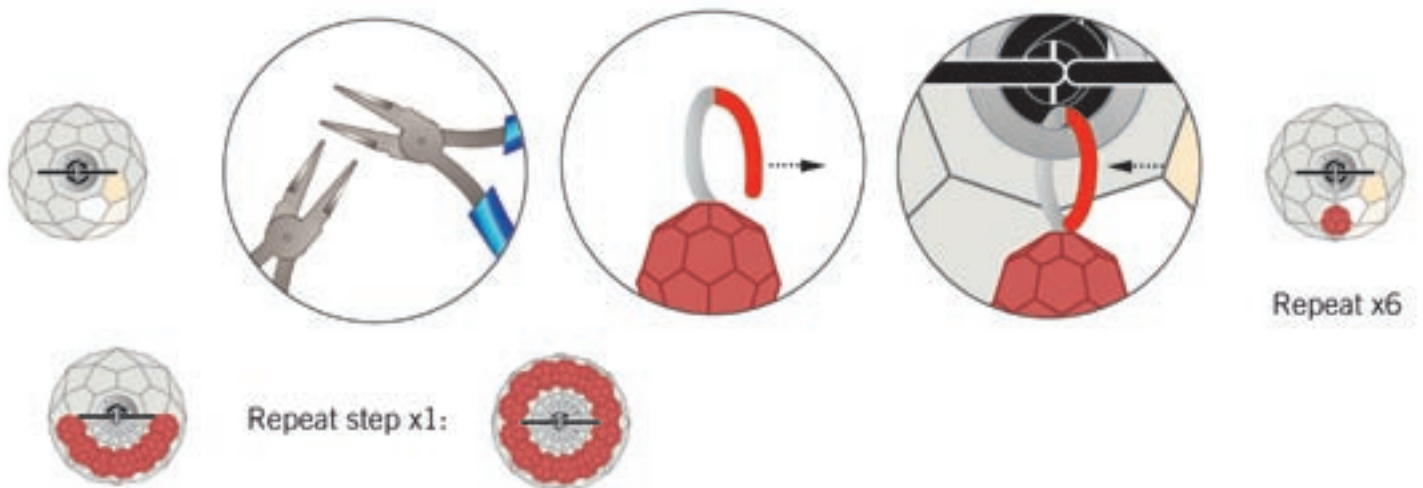

STEP 9

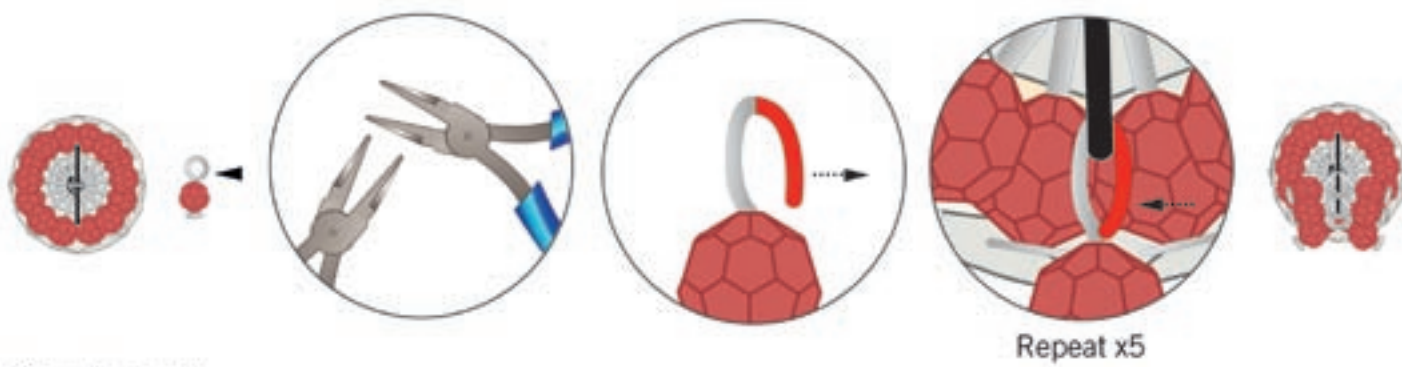

Repeat step x1:

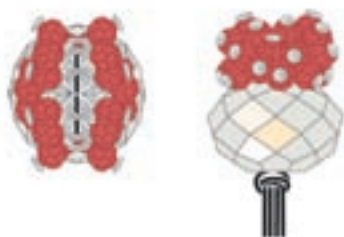

STEP 10



- STEP 1: Cut 20cm of the 0.7 mm black wire and wrap it 4x around a 4 mm thick steel stick.
- STEP 2: Turn both wire ends around each other crossing over the wraps. Remove the stick. Bend one wire end through the wrapped loop as shown in the illustration and repeat with the other end of the wire.
- STEP 3: Press the outside of the wrapped wire with the flat nose pliers. The wire ends will cross during the process. Bend both wire ends parallel again using the flat nose pliers as shown in illustration 3.
- STEP 4: Slide the CRYSTALLIZED™ Bead article 5041 onto both wire ends. Bend the two wire ends coming out of the crystal into loops using the round nose pliers as shown. Loops should be approximately 3 mm.
- STEP 5: Wrap the wire ends around the middle axis while holding the two loops with the flat nose pliers, first one end, then the other. Cut off the ends with the wire cutter. Use flat nose pliers to press cut off ends near to axis. Push wrapped part inside the bead with the tip of the tweezers (see illustration).
- STEP 6: Grip both sides of a jump ring with flat nose pliers and open the jump ring sideways. Insert it through both loops and close the jump ring.
- STEP 7: String one CRYSTALLIZED™ Bead article 5000 on a headpin and form a loop as shown in the illustration. To create the loop use the round nose pliers and cut off the remaining wire with a side cutter. Repeat to make 26 pendants.
- STEP 8: Open the headpin-loops of the pendants made in Step 7 sideways with a flat nose pliers and insert them into the jump ring of the element created in Steps 1–6. Close the headpin-loops. There will be 7 pendants on either side of the loops as shown in the illustration.
- STEP 9: Attach 6 more pendants onto either of the two loops in the same way as described in Step 8. You may wish to use tweezers to slip in the open headpin-ends into the loops when it starts to become crowded.
- STEP 10: Cut 100cm of the 2 mm black leather cord with scissors. Slide it through the wrapped loop of the pendant.