

CREATE  
YOUR STYLE with  
CRYSTALLIZED™  
-Swarovski Elements

INSPIRATION BOOK INSTRUCTION

# ICE RINGS





# ICE RINGS

## CRYSTALLIZED™ – Swarovski Elements

Article	Product Group	Article No.	Amount	Size	Colour	Colour Code
	Fancy Stones	4139	1 pc.	14 mm	Crystal Vitrail Light	001 VL
	Beads	5000	1 pc.	6 mm	Violet Opal	389
	Beads	5328	6 pcs.	6 mm	White Opal	234

## Supplies & Tools

- Supplies**
- 7 Headpins, silver, 0.7x45 mm
  - Wire, black, Ø 0.7 mm, 100 cm
  - Wire, black, Ø 0.4 mm, 10 cm
- Tools**
- Flat nose pliers
  - Ring mandrel
  - Round nose pliers
  - Scissors
  - Steel stick, 1.7 mm, 1.2 mm
  - Tweezers
  - Wire cutter

Level of design: BEGINNERS

Have also a look at the **text instruction** at the last page!

### STEP 1

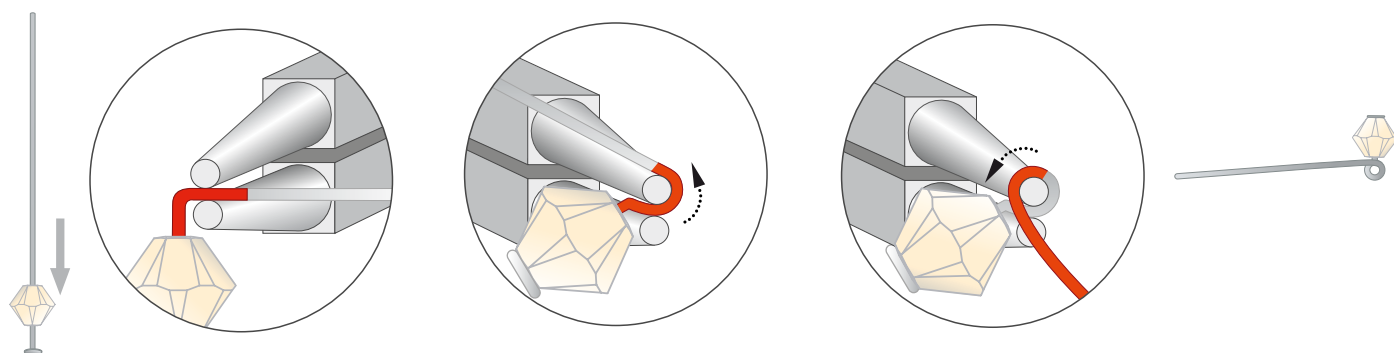

### STEP 2

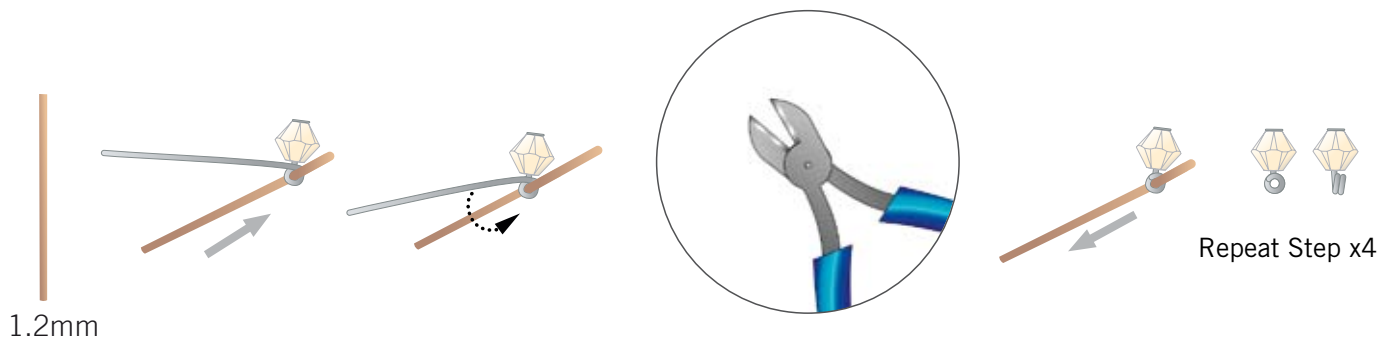

STEP 3

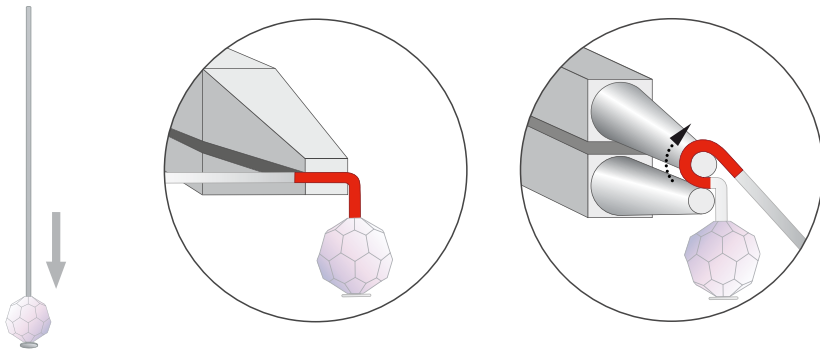

STEP 4

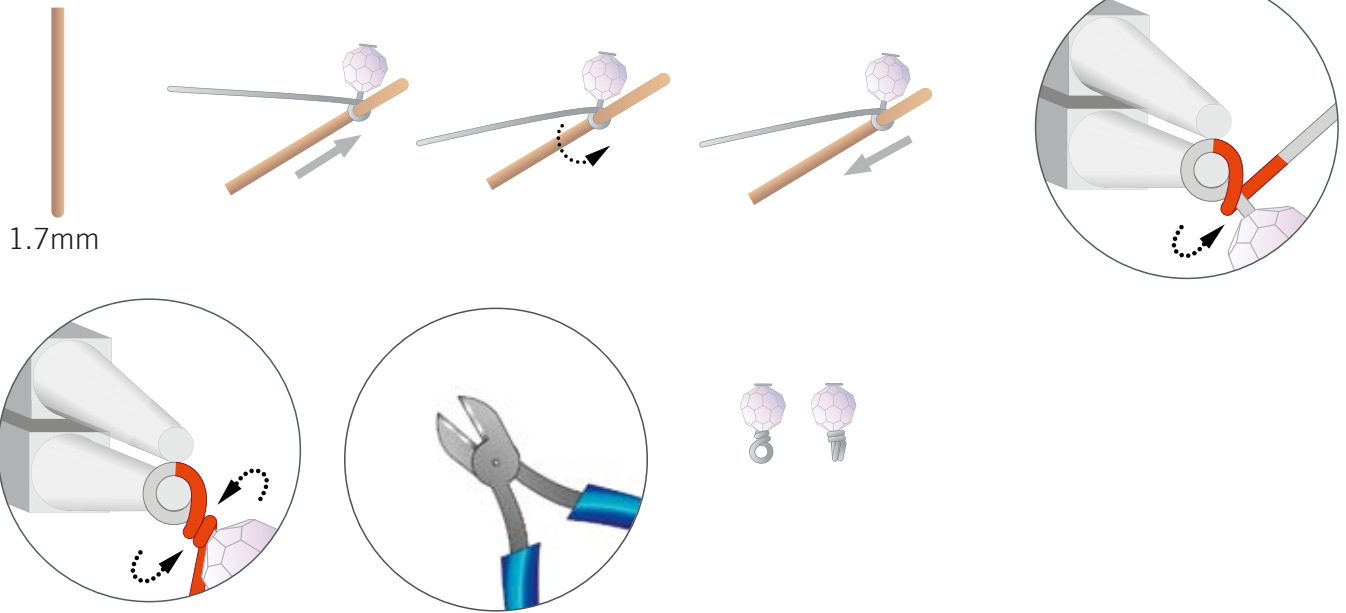

STEP 5

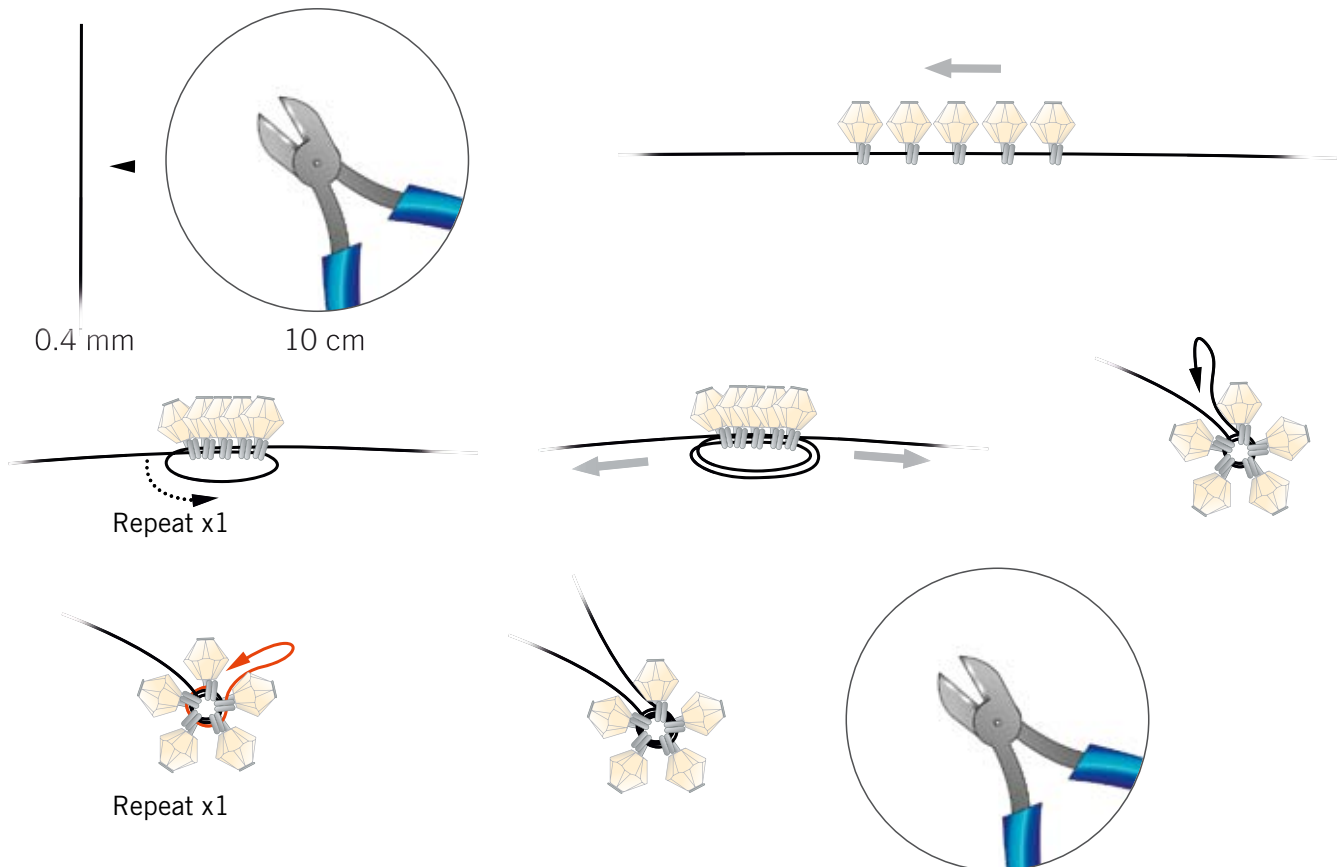

STEP 6

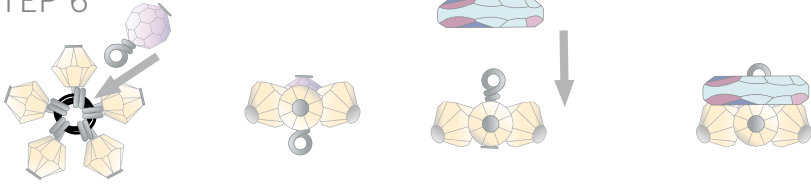

STEP 7

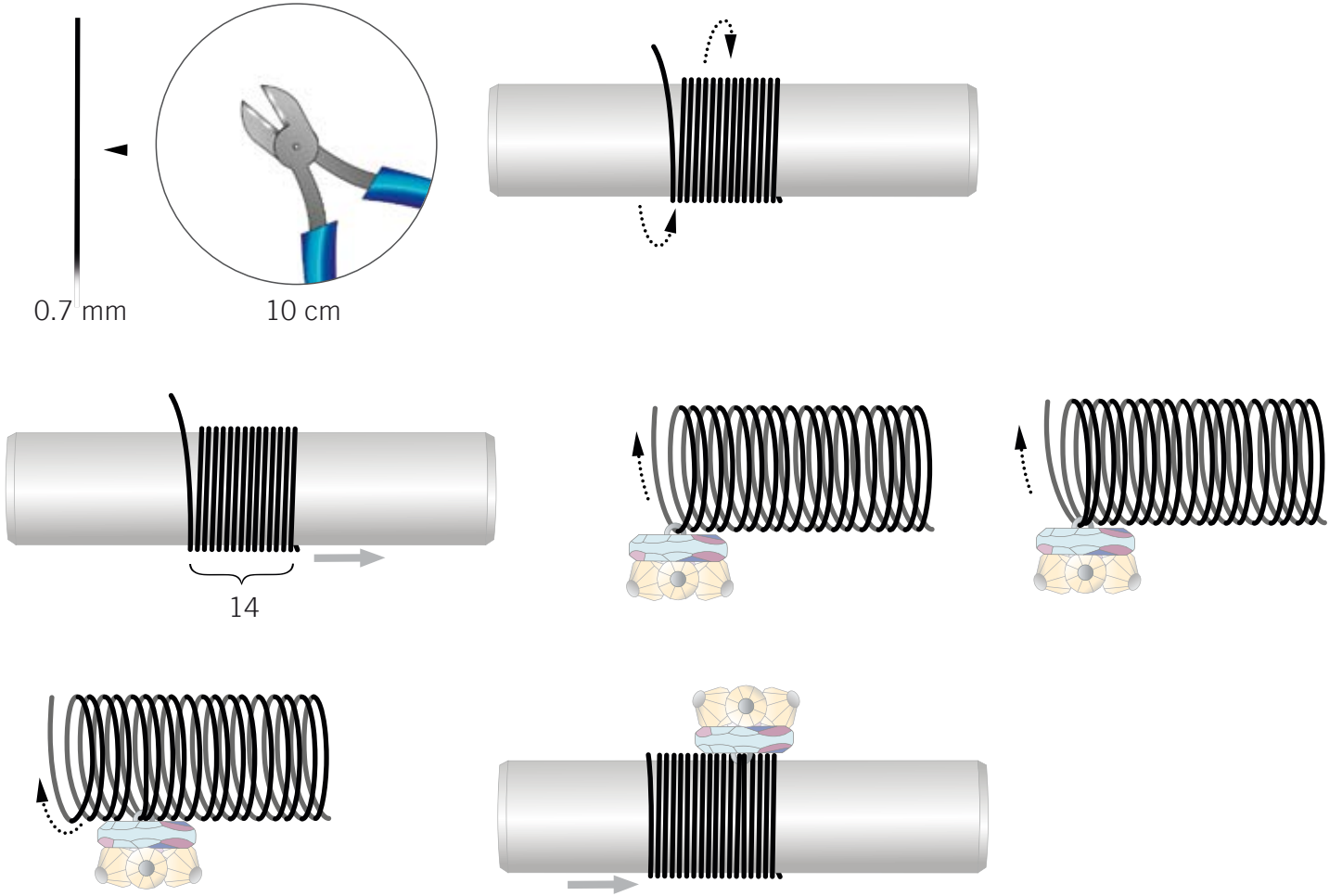

STEP 8

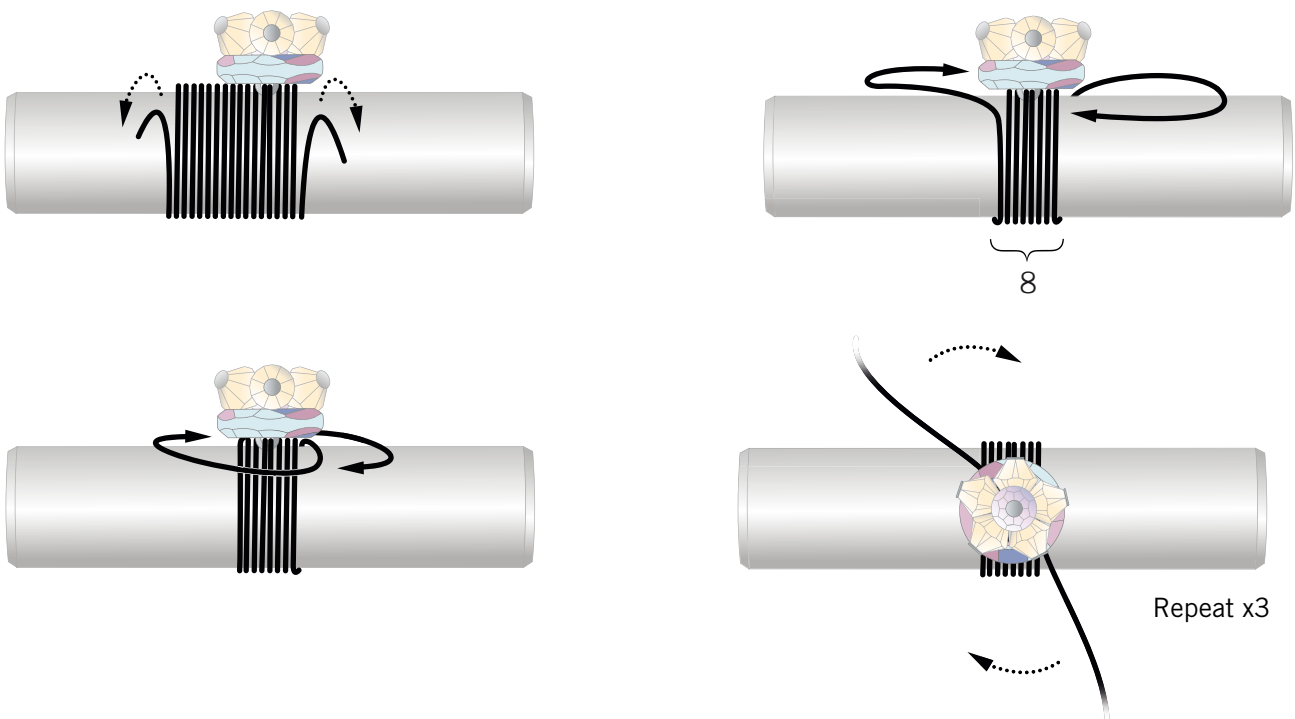

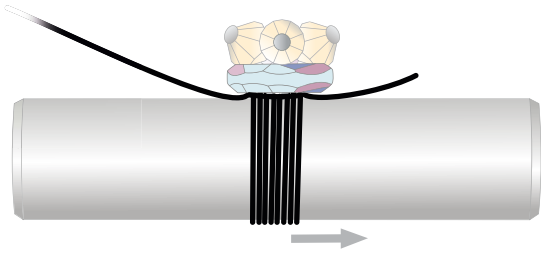

STEP 9

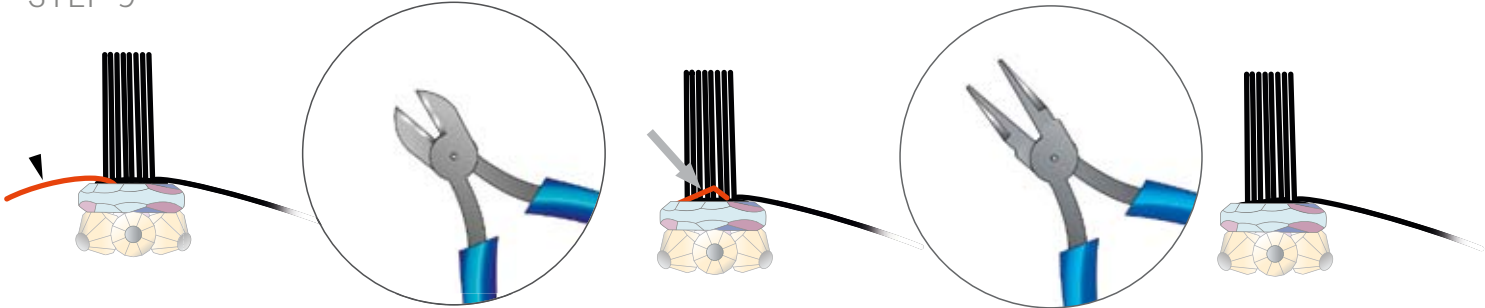

STEP 10

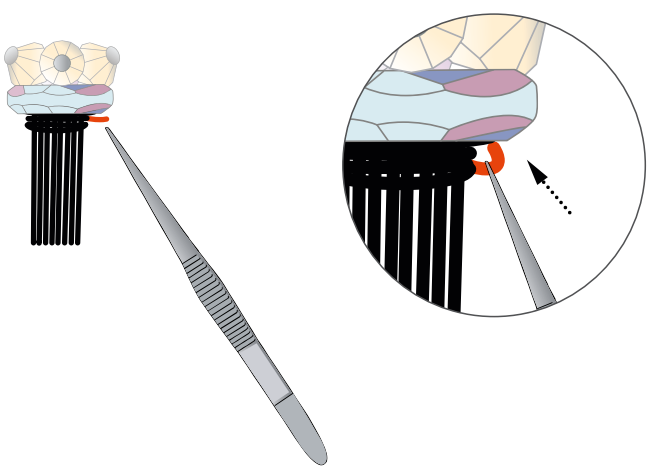
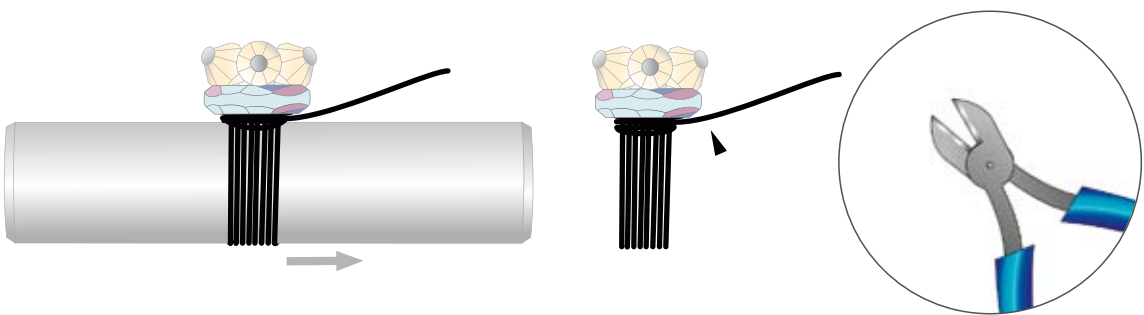
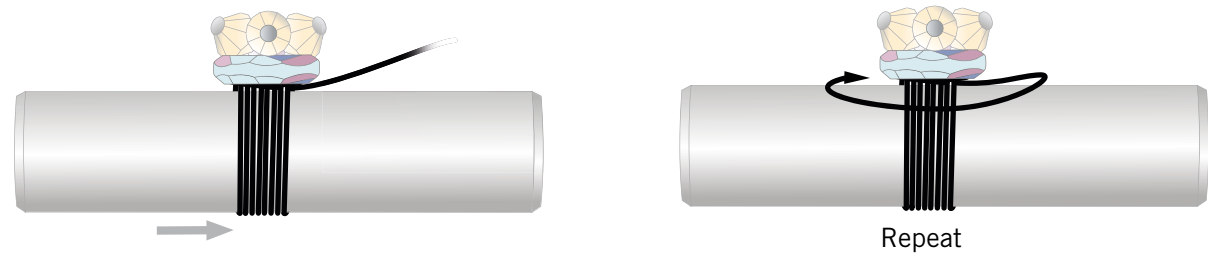

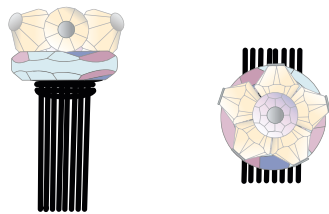

- STEP 1: Slide one CRYSTALLIZED™ Bead article 5328 6 mm in White Opal onto a headpin and form a loop with round nose pliers as you see in illustration.
- STEP 2: Insert the 1.2 mm stick into the loop and bend the wire once more around the stick. Cut off wire end with side cutter after second full loop and remove stick.
- STEP 3: Slide one CRYSTALLIZED™ Bead article 5000 6 mm in Violet Opal onto a headpin and form a loop with about 3 mm distance to the bead.
- STEP 4: Insert the 1.7 mm stick into the loop and bend the wire once more around the stick. Remove stick and hold the two rounds with the round nose pliers and twist wire two times back.
- STEP 5: Cut 10 cm of the 0.4 mm wire and string the 6 CRYSTALLIZED™ Beads with loops onto it. Have a look onto picture in illustration. All wraps should go to the same side. Bend each wire end once through all beads and pull tight like you see in illustration. Pass both wire ends through all loops and cut off rest..
- STEP 6: Pass the CRYSTALLIZED™ Bead article 5000 with wire loop through the middle of bead circle and place the CRYSTALLIZED™ Fancy Stone article 4139 over the wrapped loops of the 5000-pendant. Have a look onto illustration.
- STEP 7: Cut 10 cm of the 0.7 mm wire. Twist the wire around the ring mandrel. String one end of spiral through loop of CRYSTALLIZED™ Beads article 5000 like you see in illustration. Turn spiral until 2 loops of it are inside the loop. Rotate again 4 loops further but without inserting the spiral end into the loop. Have a look onto pictures in illustration. Insert the mandrel again.
- STEP 8: Open the loops until there remain 3 loops on either side of the two loops which pass the inside the loop of CRYSTALLIZED™ Beads article 5000. Have a look onto illustration. Wrap with both wire ends x4 around like you see in illustration and remove mandrel again.
- STEP 9: Cut one wire end short and hide it with flat nose pliers inside the CRYSTALLIZED™ Fancy Stone article 4139.
- STEP 10: Insert the mandrel and wrap remaining wire end 2 times around like you see in illustration. Cut off wire and hide wire end with tweezers.