

CREATE
YOUR STYLE with
CRYSTALLIZED™
-Swarovski Elements

INSPIRATION BOOK INSTRUCTION

CIRCLE EARRINGS



CIRCLE EARRINGS



CRYSTALLIZED™ – Swarovski Elements

Article	Product Group	Article No.	Amount	Size	Colour	Colour Code
	Sew-on Stones	3128	4 pcs.	5 mm	Topaz	203
	Beads	5000	12 pcs.	2 mm	Jet	280
	Beads	5000	20 pcs.	2 mm	Topaz	203
	Beads	5000	2 pcs.	3 mm	Amethyst	204
	Beads	5000	12 pcs.	3 mm	Topaz	203
	Beads	5000	12 pcs.	4 mm	Topaz	203
	Beads	5000	4 pcs.	6 mm	Topaz	203
	Beads	5181	4 pcs.	13x7 mm	Jet	280
	Beads	5181	2 pcs.	17x9 mm	Amethyst	204

Supplies & Tools

- Supplies**
- 2x Fish hook ear wire, silver black
 - 8cm Nylon thread, transparent, Ø 0.3 mm
 - 8cm Nylon thread, transparent, Ø 0.6 mm
 - 3m Wire, dark purple, Ø 0.3 mm
 - 3m Wire, silver plated, Ø 0.6 mm
- Tools**
- Flat nose pliers
 - Round nose pliers
 - Wire cutter

Level of design: BEGINNERS

Have also a look at the **text instruction** at the last page!

STEP 1

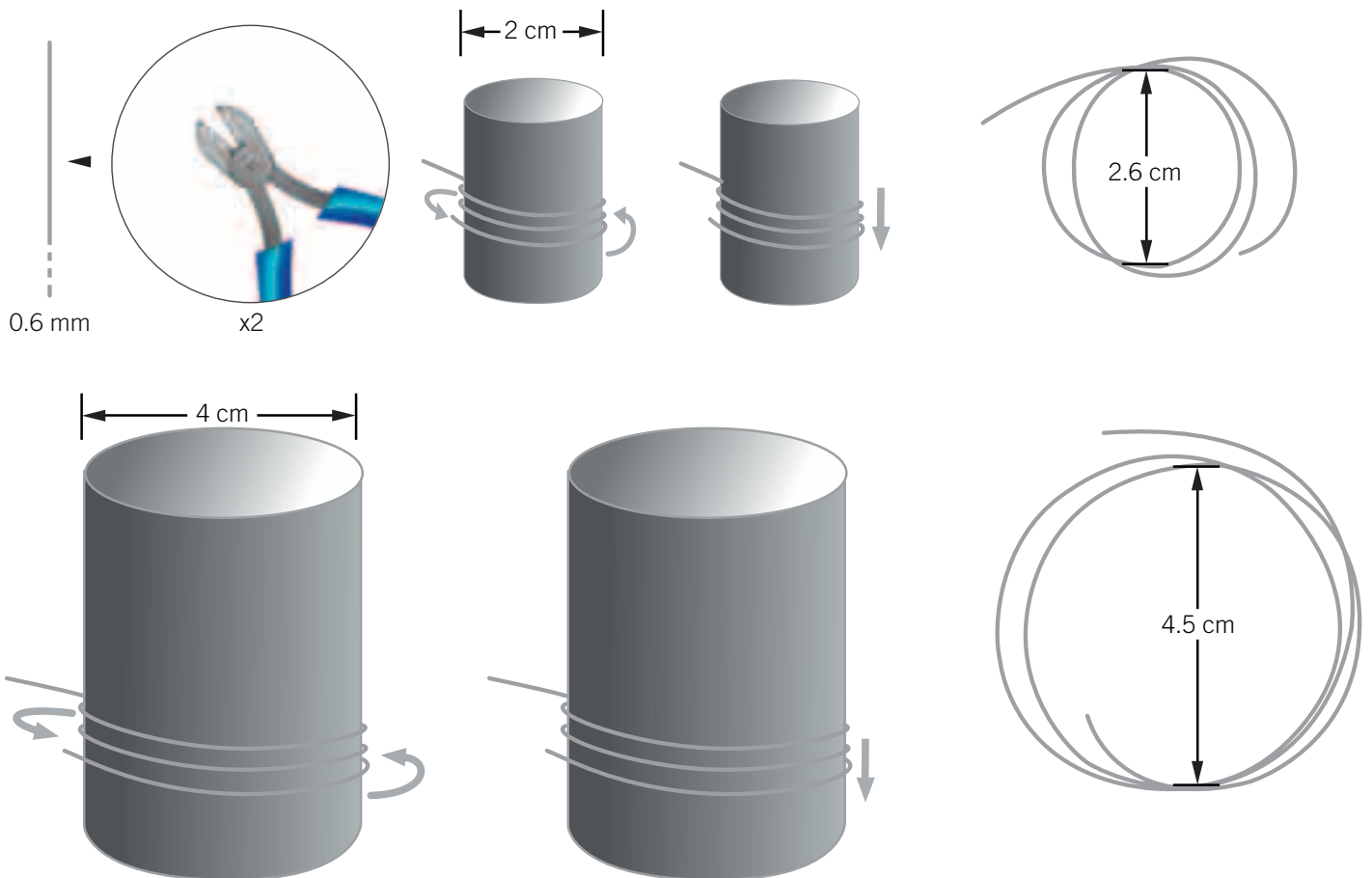

STEP 2

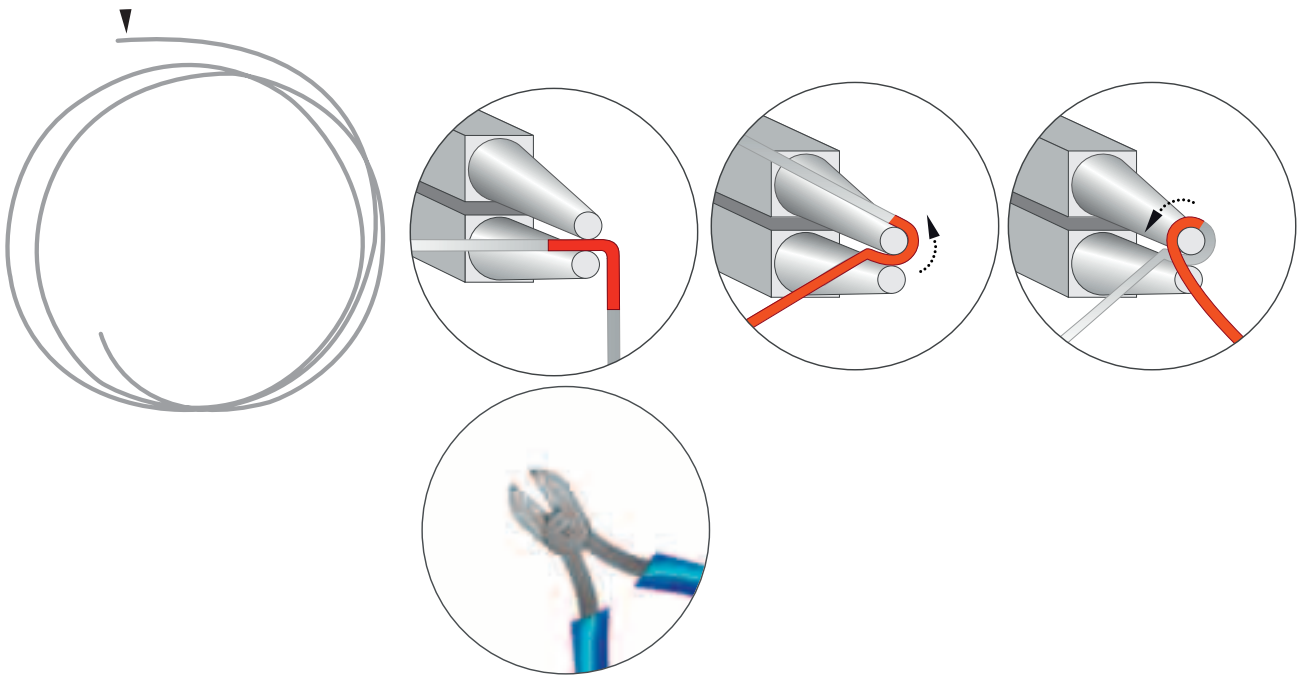

STEP 3

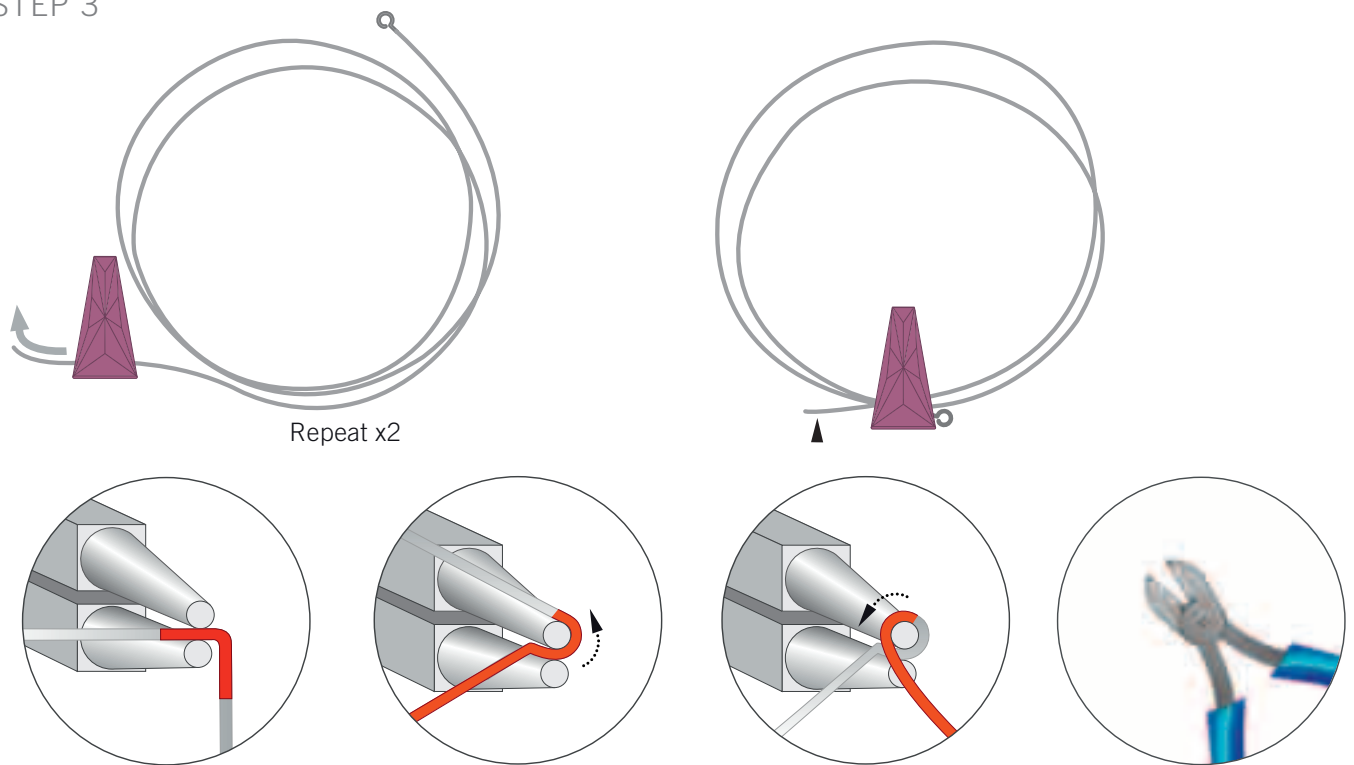

STEP 4

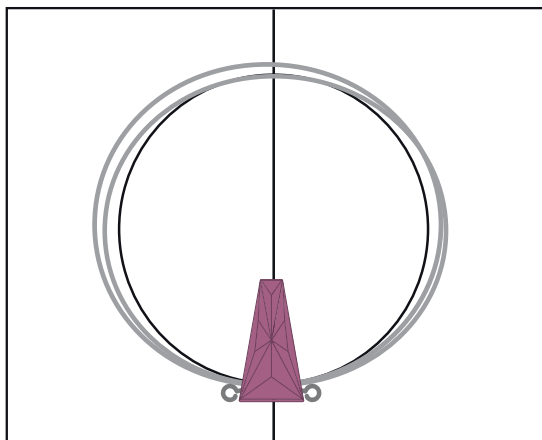
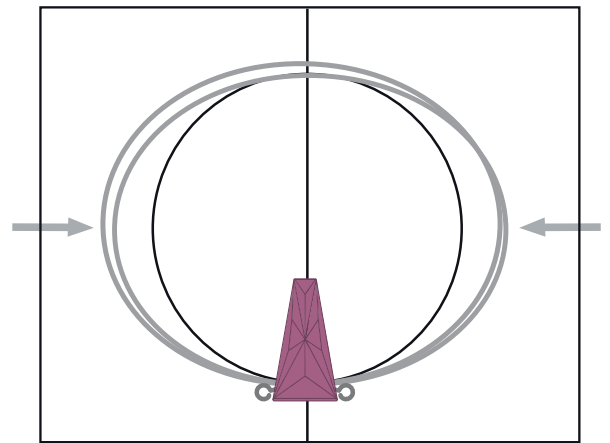
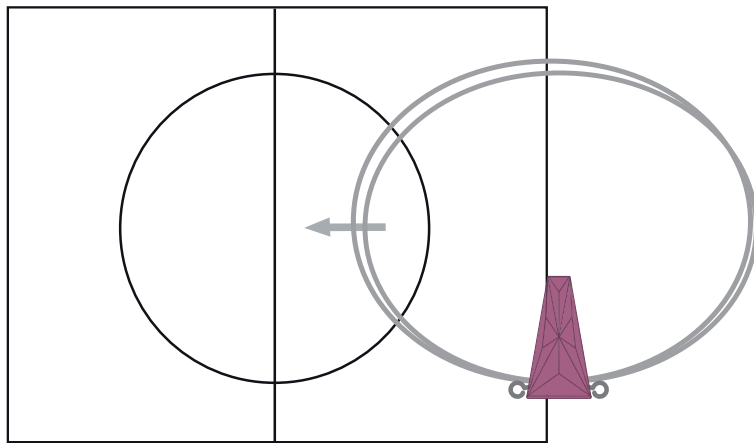
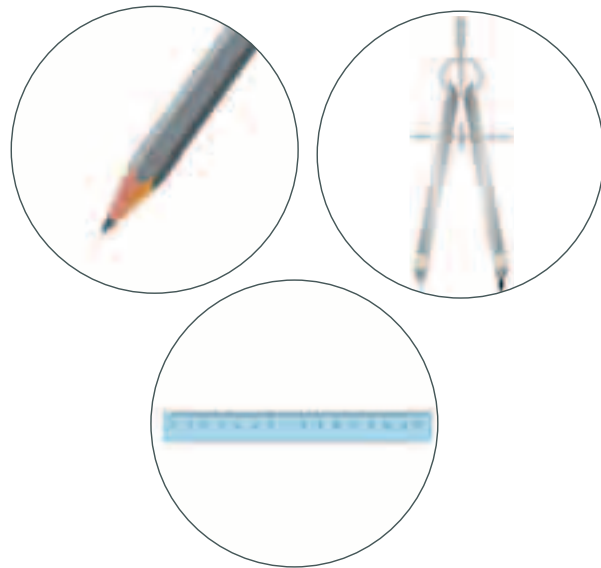
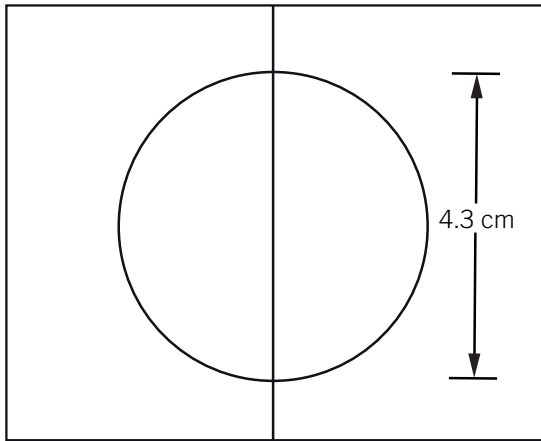

STEP 5

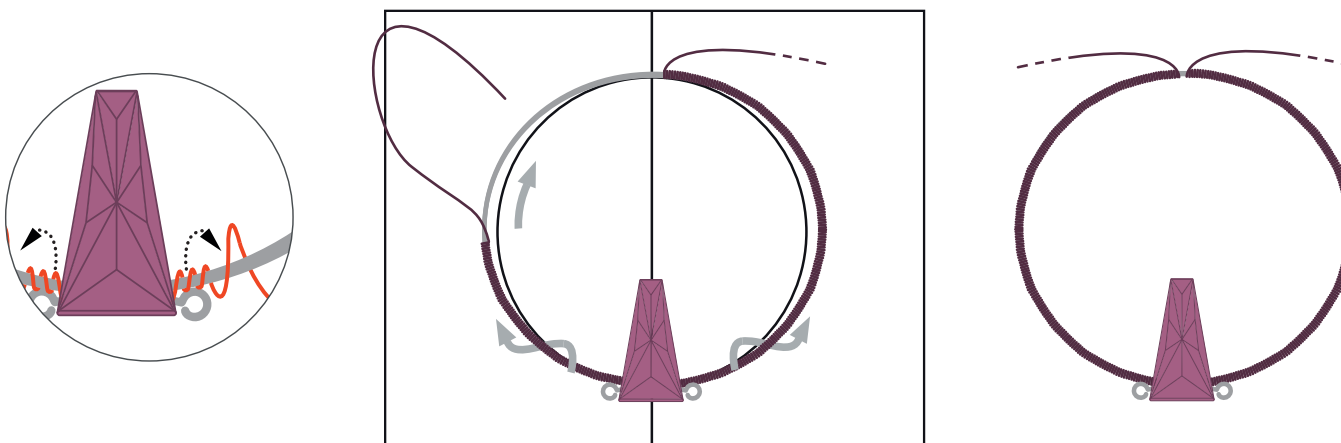
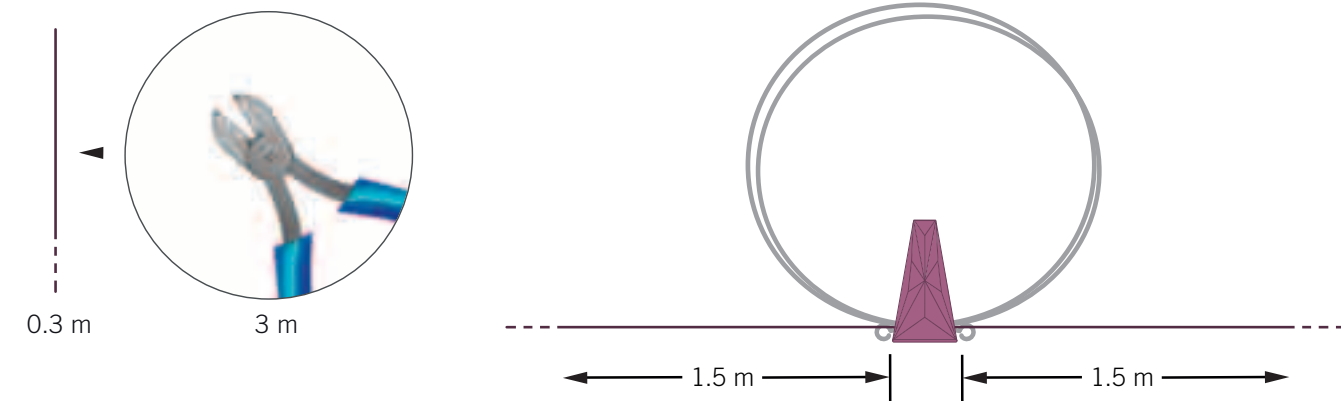

STEP 6

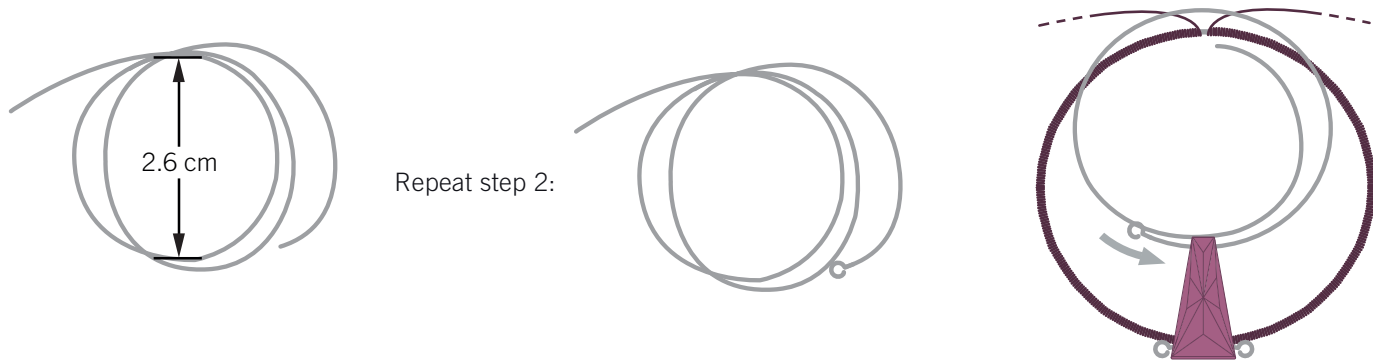

STEP 7

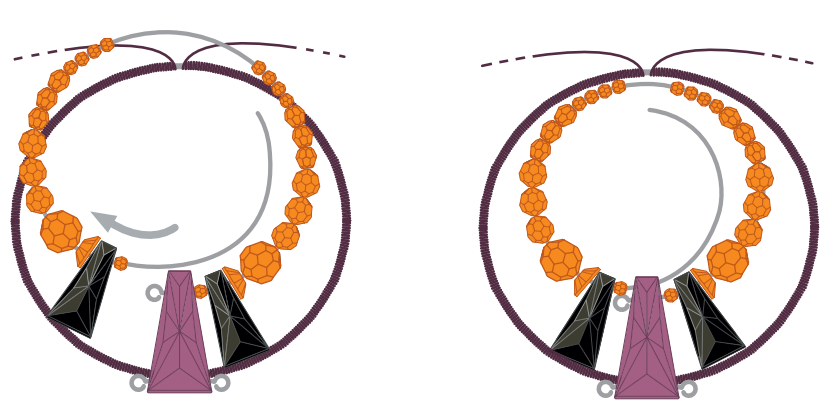

STEP 8

Repeat steps 4

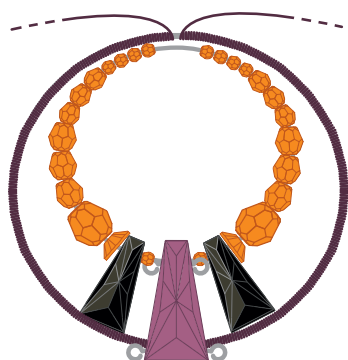
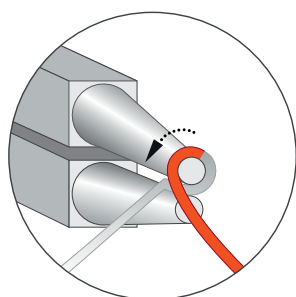
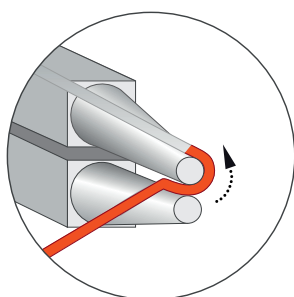
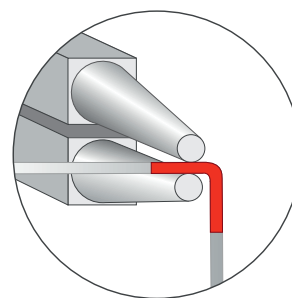
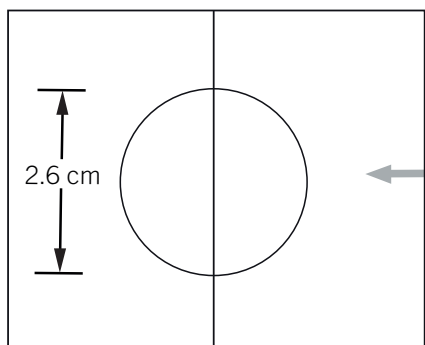

STEP 9

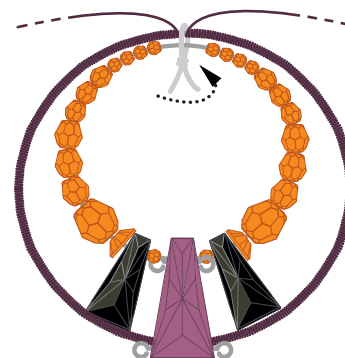
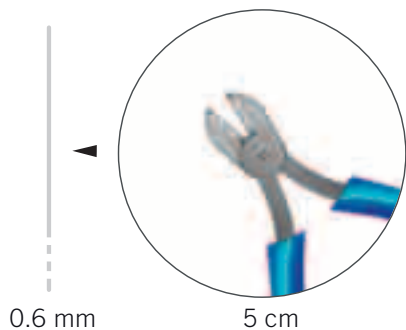

STEP 10

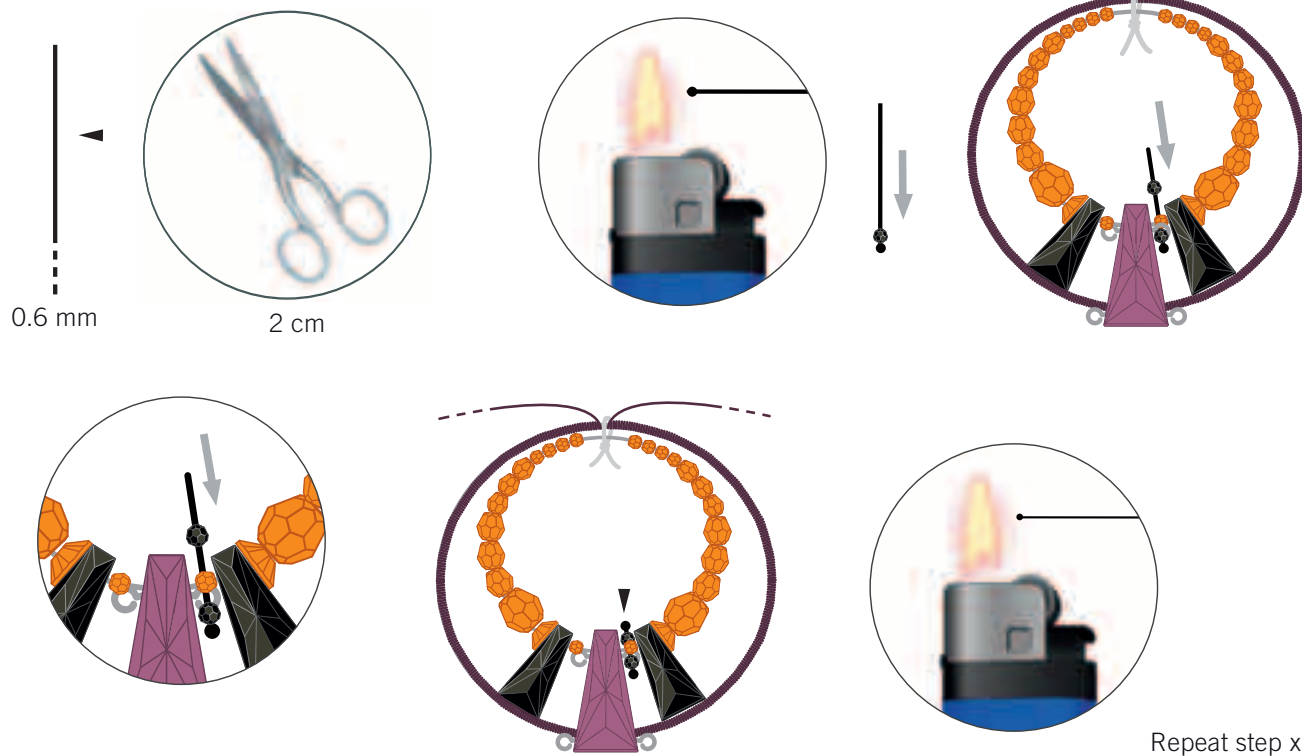

STEP 11

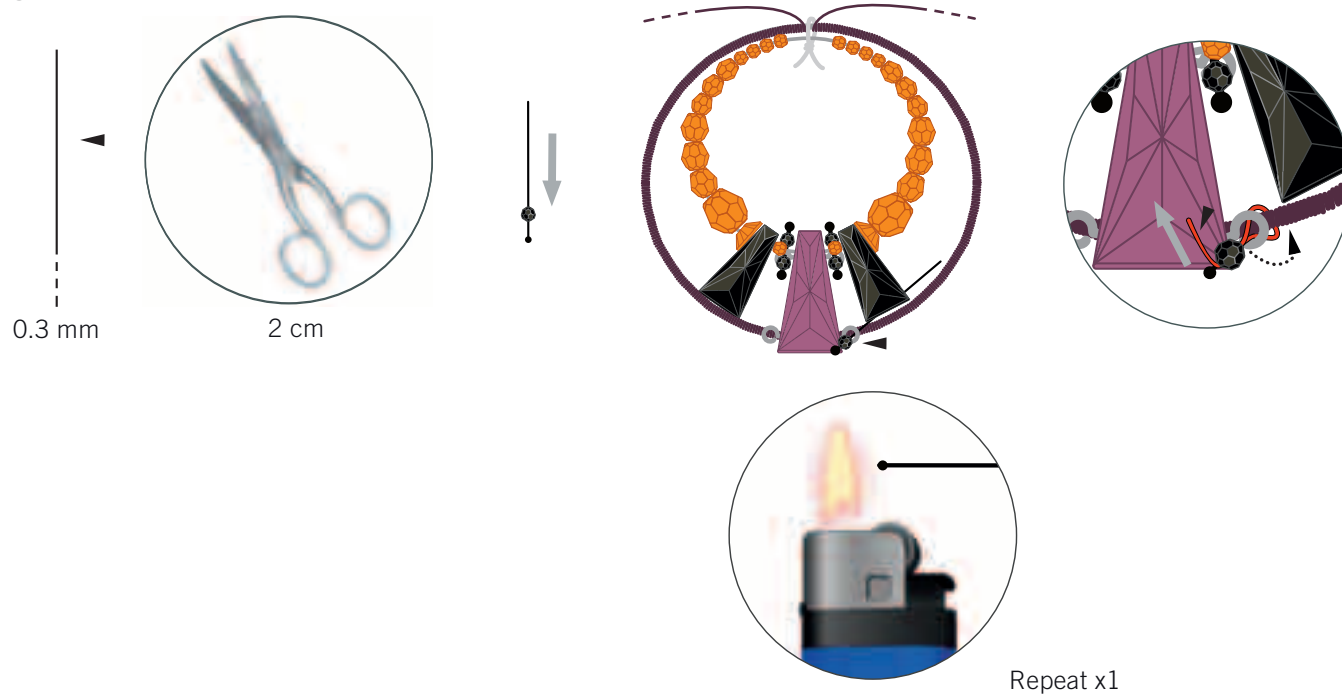

STEP 12

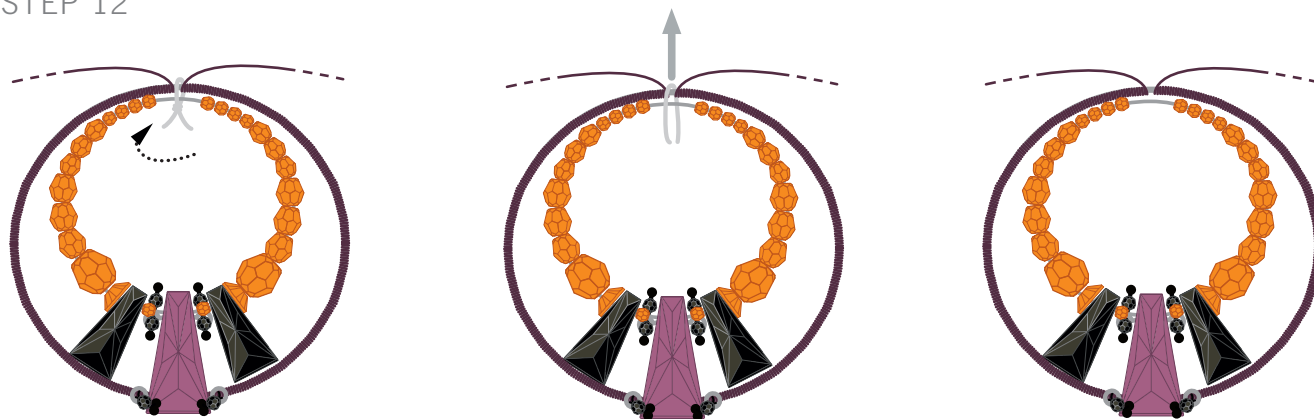

STEP 13

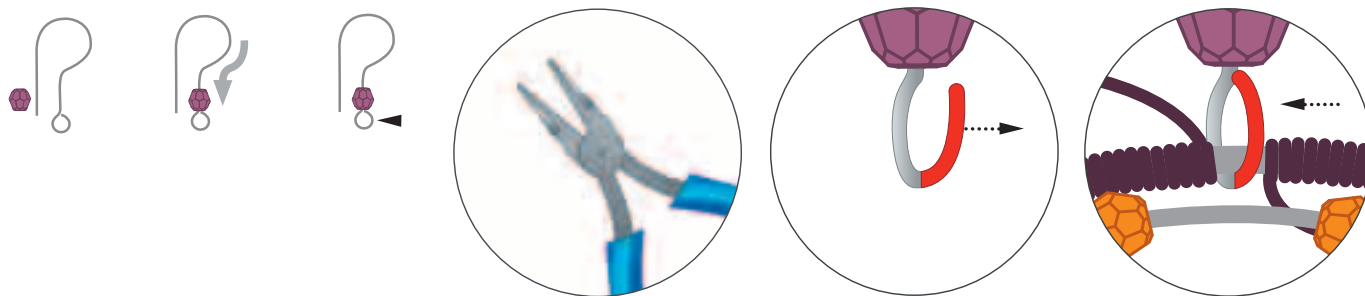

STEP 14

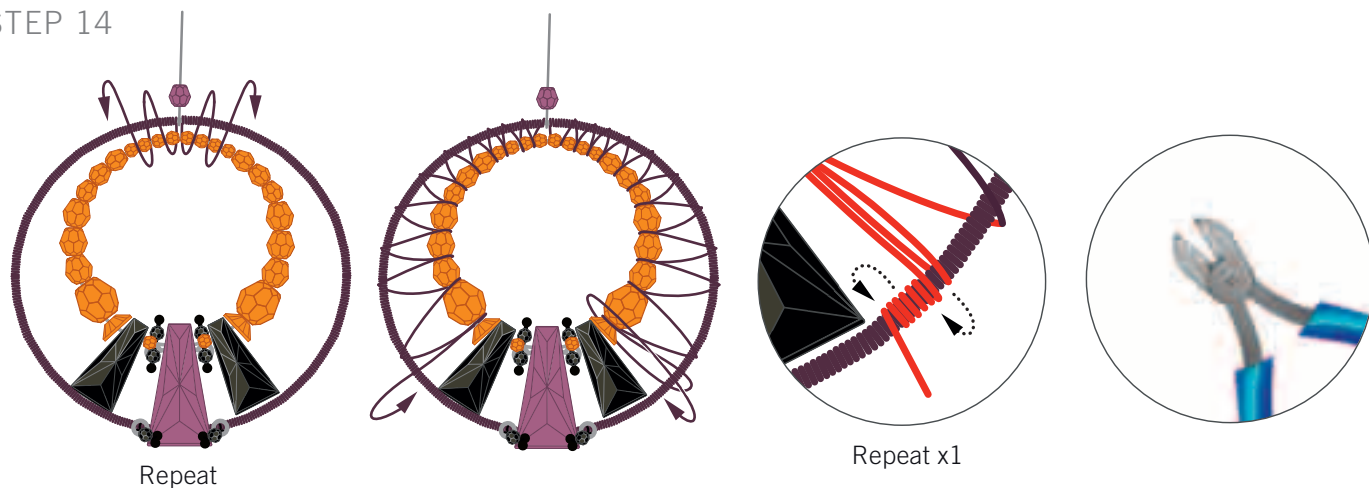

Repeat steps 1 – 14 x1



- STEP 1: Wrap silver wire tightly several times around an object with 2 cm diameter. Repeat with a 4 cm diameter object.
- STEP 2: Take the bigger wire loop and make a small loop on one end with round nose pliers.
- STEP 3: Slide on the CRYSTALLIZED™ Bead 5181 in Amethyst all the way to the end. Make a loop at other end of wire (see illustration).
- STEP 4: Draw a 4.3 cm circle onto a sheet of paper and place the silver wire with the bead from step 3 onto the drawn circle. Adjust the wire loop to fit the drawn circle if necessary.
- STEP 5: Cut 3 m of the 0.3 mm wire and slide it through the lower hole of bead and wrap each end around the silver wires.
- STEP 6: Take the smaller wires with the 2.6 cm diameter and Repeat step 2 (see illustration).
- STEP 7: Slide onto wire loop Crystallized™ Beads as you see in illustration. Then go through 5181 Amethyst Bead with wire end.
- STEP 8: Repeat step 4 with a drawing of a 2.6 cm circle. Form with wire end a loop with round nose pliers and cut off excess.
- STEP 9: Cut 5 cm of 0.6 mm wire and wrap it around the 2.6 cm circle and the 4.3 cm circle to hold them together as shown.
- STEP 10: Cut 2 cm of 0.6 mm nylon thread and melt one end and slide on one Crystallized™ Bead 5000 2 mm in Jet. Thread the nylon thread through one of the small wire loops in the 2.6 cm circle, slide on a second Crystallized™ Bead 5000 2 mm in Jet and melt the end to a ball. Repeat step for second small loop in this circle.
- STEP 11: Cut a piece of 0.3 mm nylon thread and slide on one Crystallized™ Bead 5000 2 mm in Jet thread nylon thread through the other one small wire loop on the other side of this 2/6 cm circle. Thread around the wire and back through bead as you see in illustration and melt nylon thread end to a ball. Repeat this step for second loop in this circle.
- STEP 12: Remove small wire piece from step 9.
- STEP 13: Take the fish ear wire hook and slide on one Crystallized™ Bead 5000 3 mm in Amethyst. Open the loop of ear wire and close it around earring as you see in illustration.
- STEP 14: Take the 2 remaining 0.3 mm wire ends and wrap them around small circle and bigger circle as you see in illustration. At the end wrap wire ends just around bigger circle and cut off excess. Repeat all steps to get a second earring.