

CREATE
YOUR STYLE with
CRYSTALLIZED™
-Swarovski Elements

INSPIRATION BOOK INSTRUCTION

SNOWFLAKE BOOK COVER



BOOK COVER



CRYSTALLIZED™ – Swarovski Elements

Supplies & Tools

Article	Product Group	Article No.	Amount	Size	Colour	Colour Code
	Beads	5328	110 pcs.	4 mm	Crystal Moonlight	001 MOL

Supplies
 Book, 14.5x21.5x4 cm
 Felt, brown, 50x25 cm
 Yarn, cream white, 8 m

Tools
 Beading needle
 Iron
 Needle
 Scissors

Level of design: BEGINNERS

Have also a look at the **text instruction** at the last page!

STEP 1

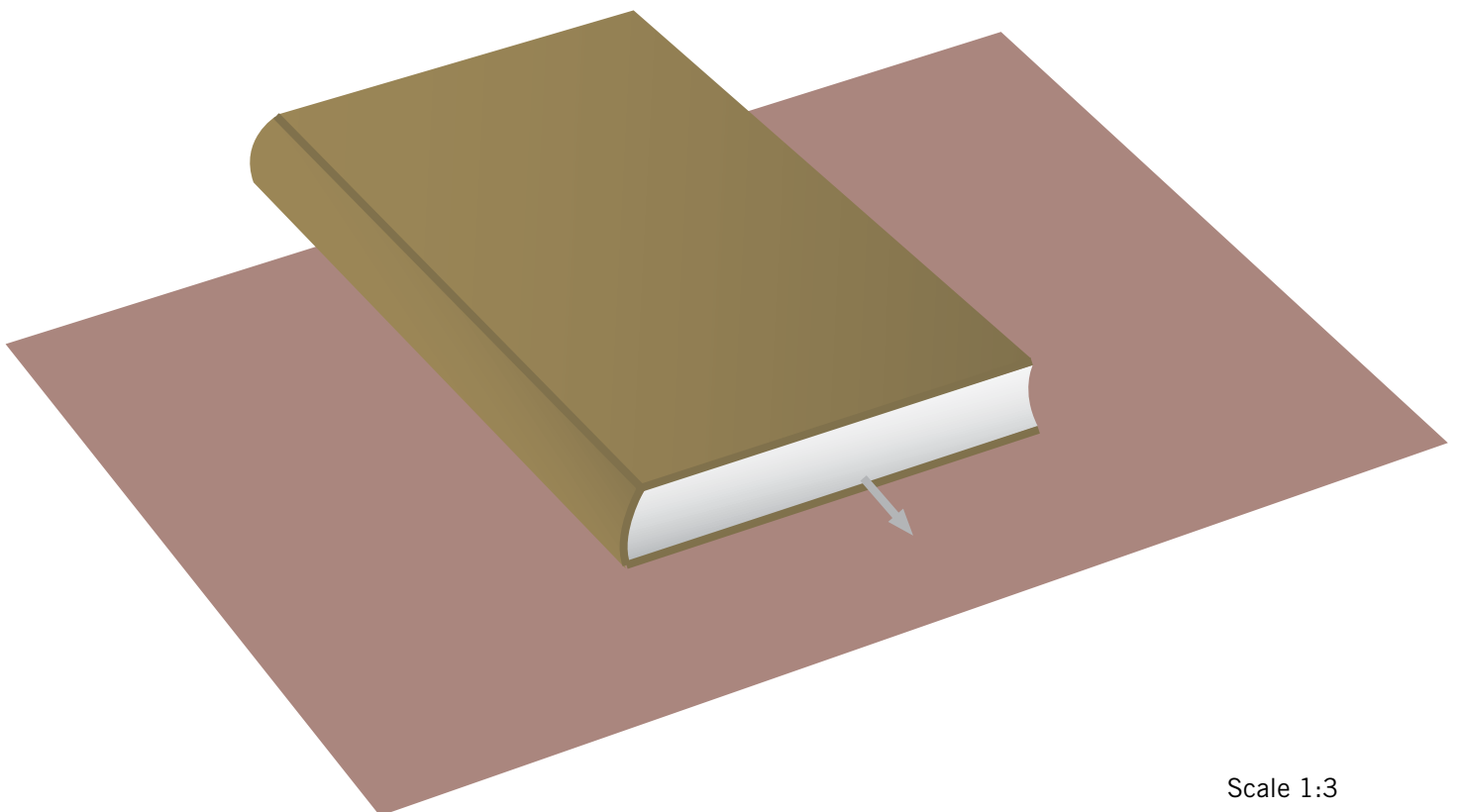

Scale 1:3

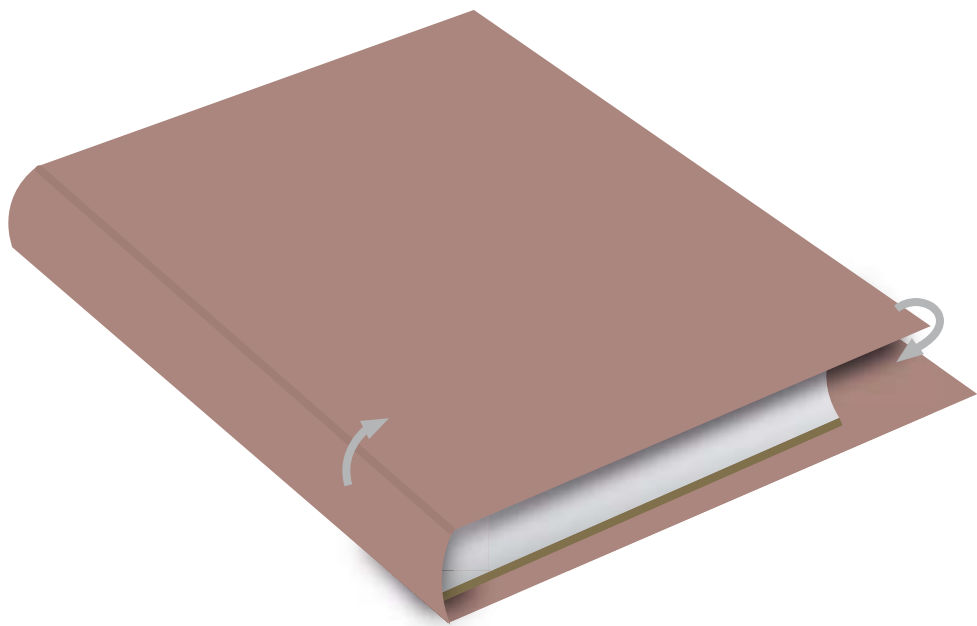
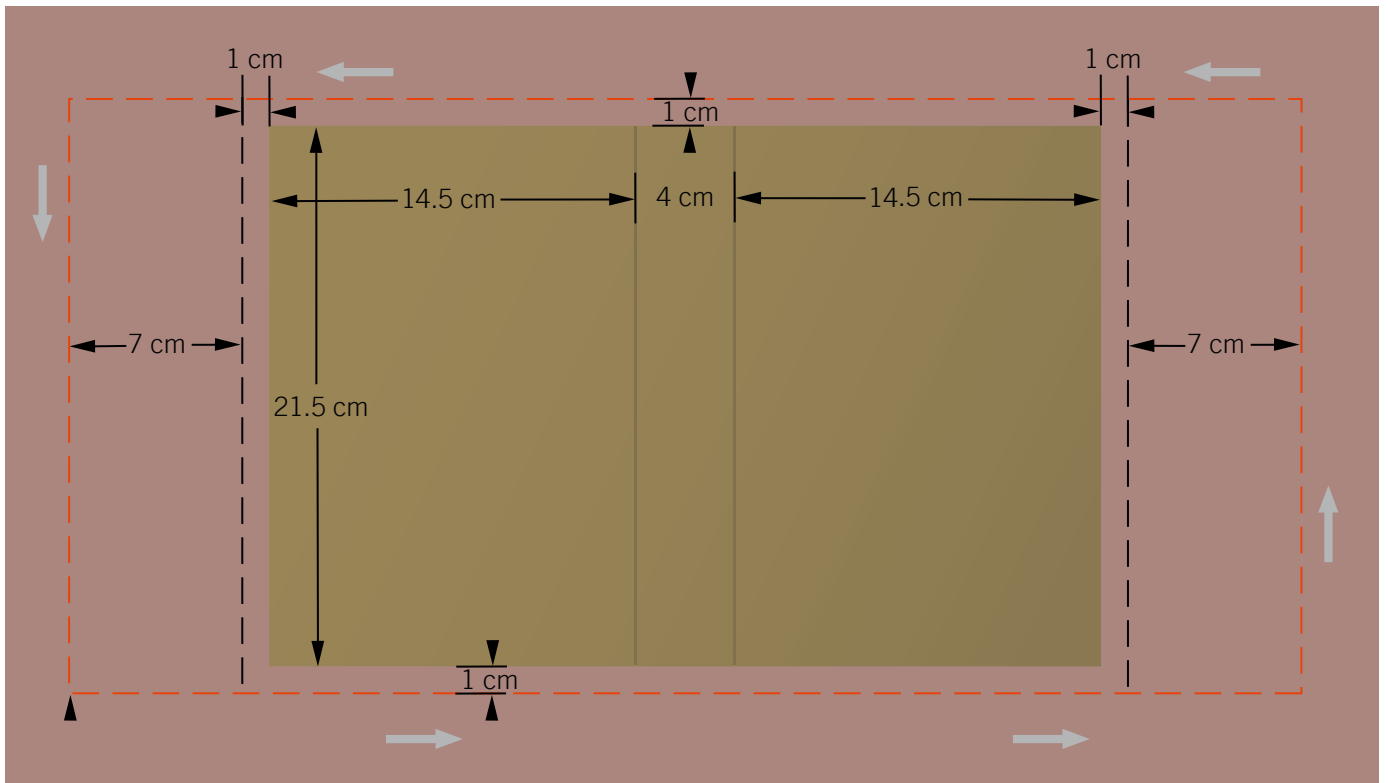

STEP 2

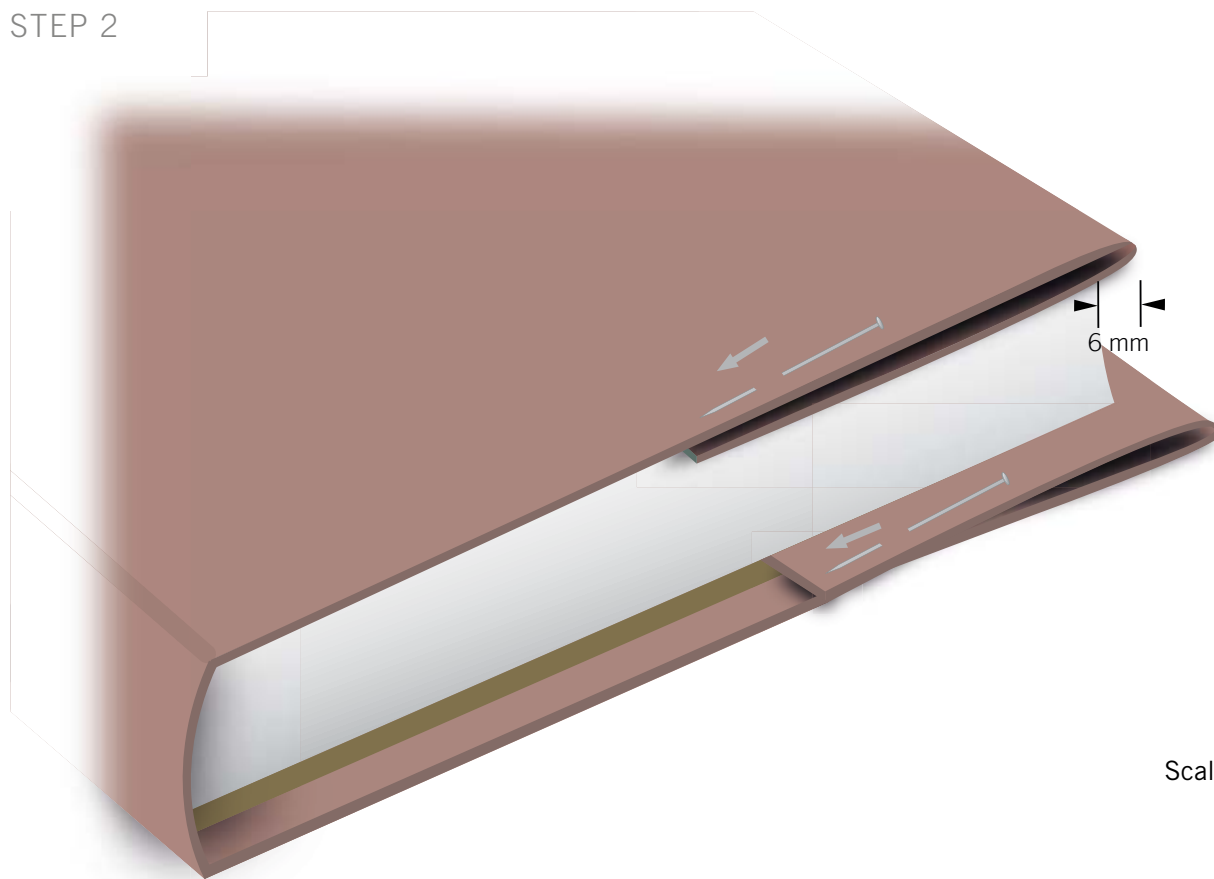

Scale 1:1

STEP 3

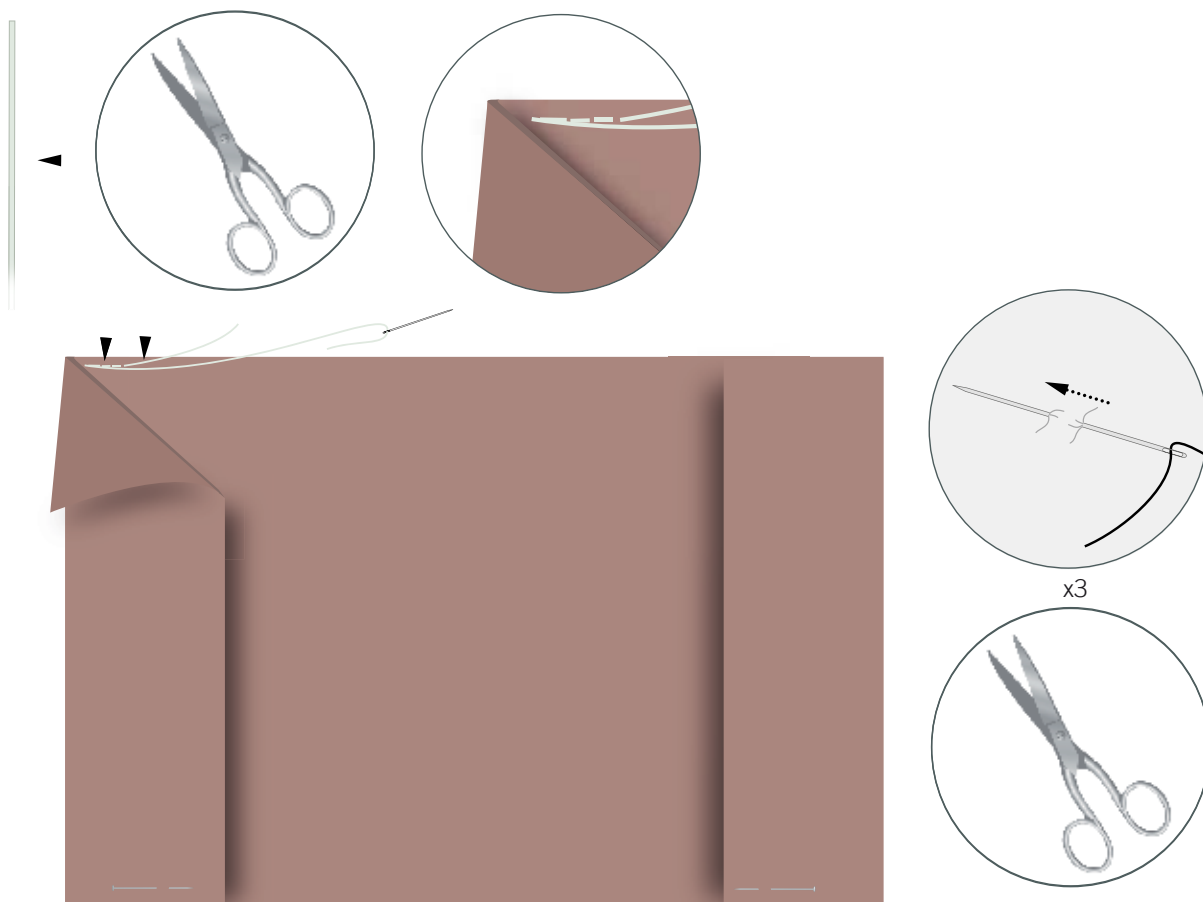

Scale 1:3

STEP 4

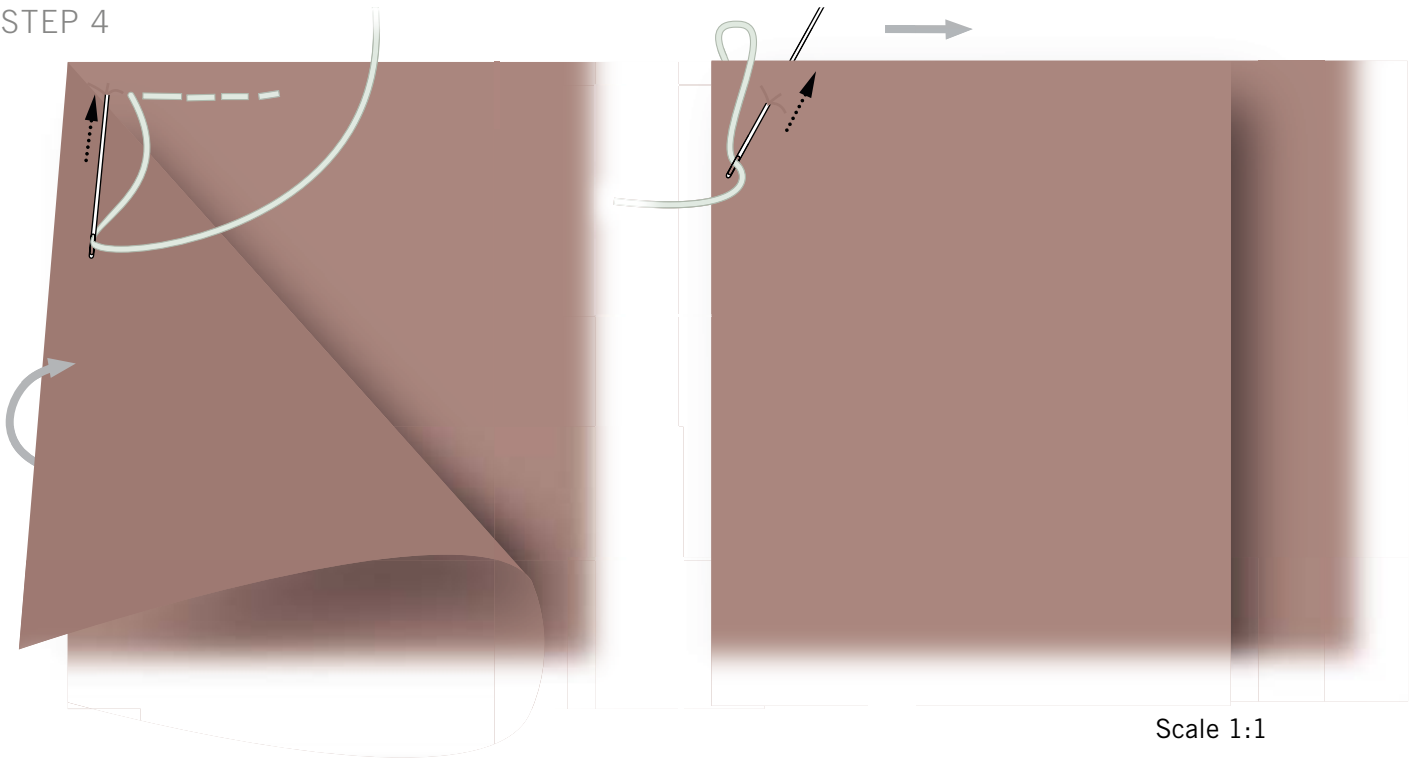

Scale 1:1

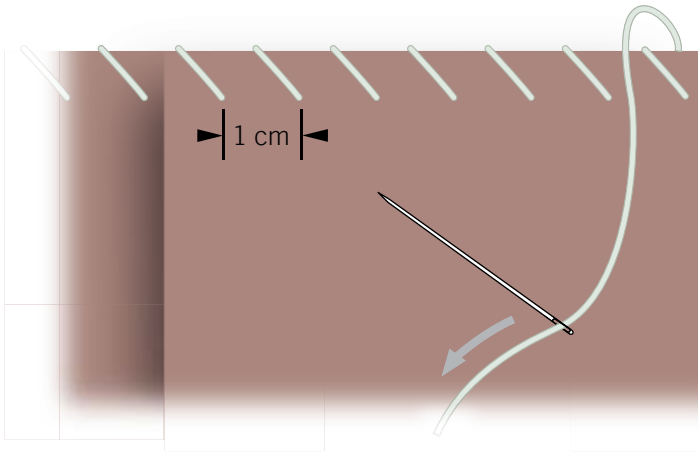

STEP 5

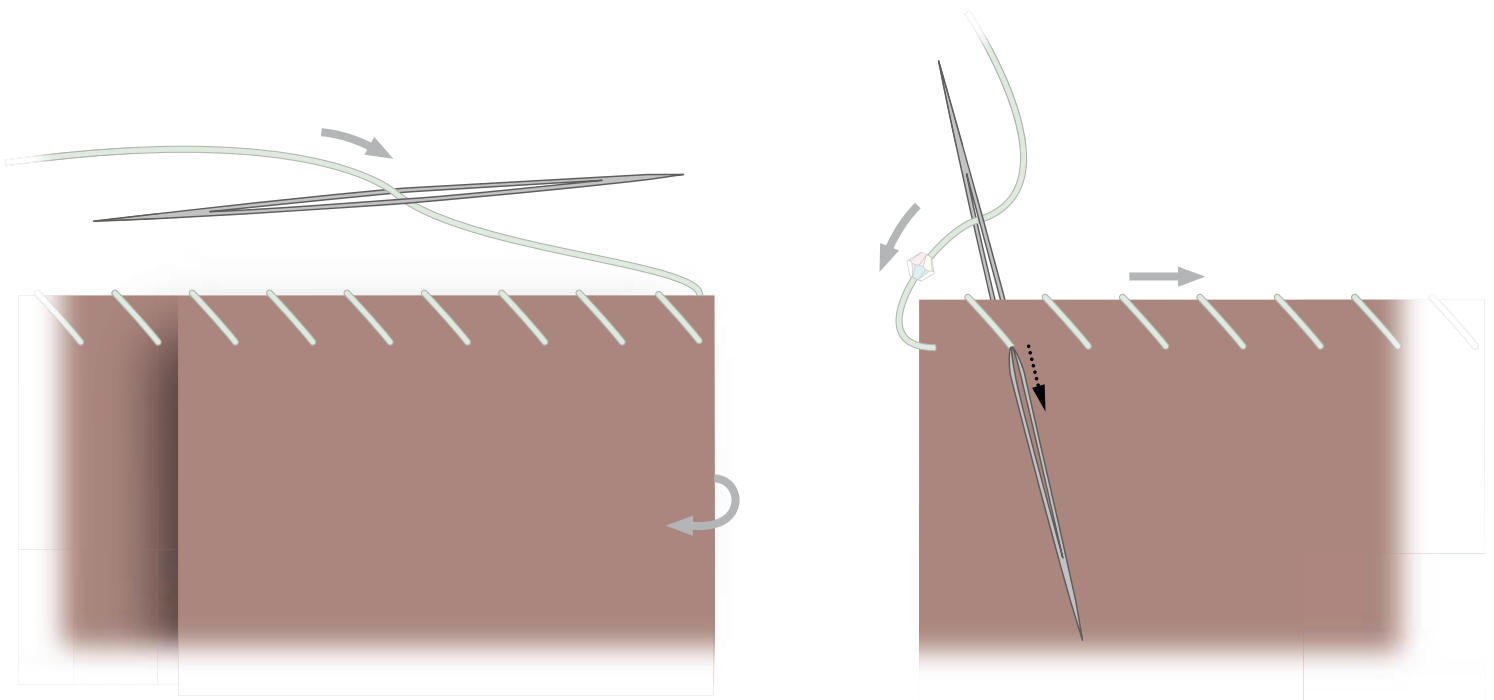

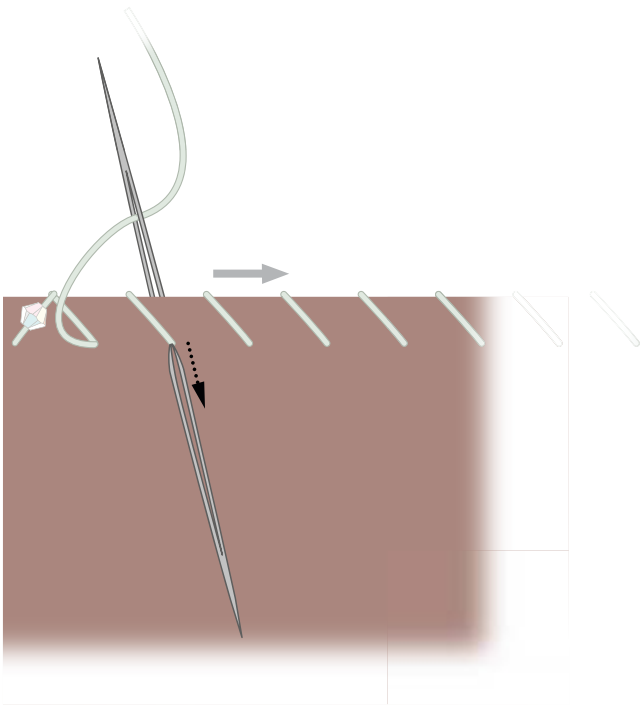

STEP 6

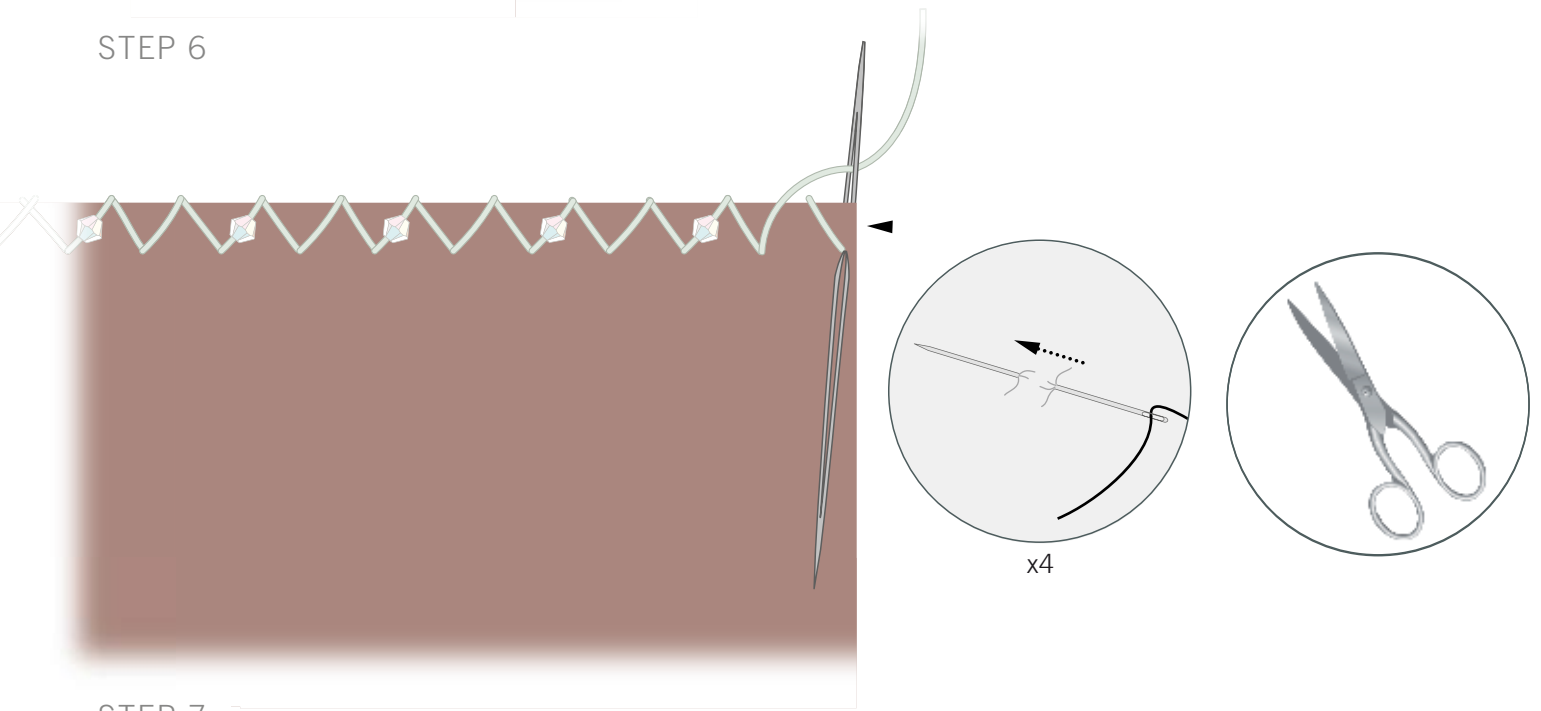

STEP 7



Repeat steps 4 - 6

Scale 1:3



STEP 8

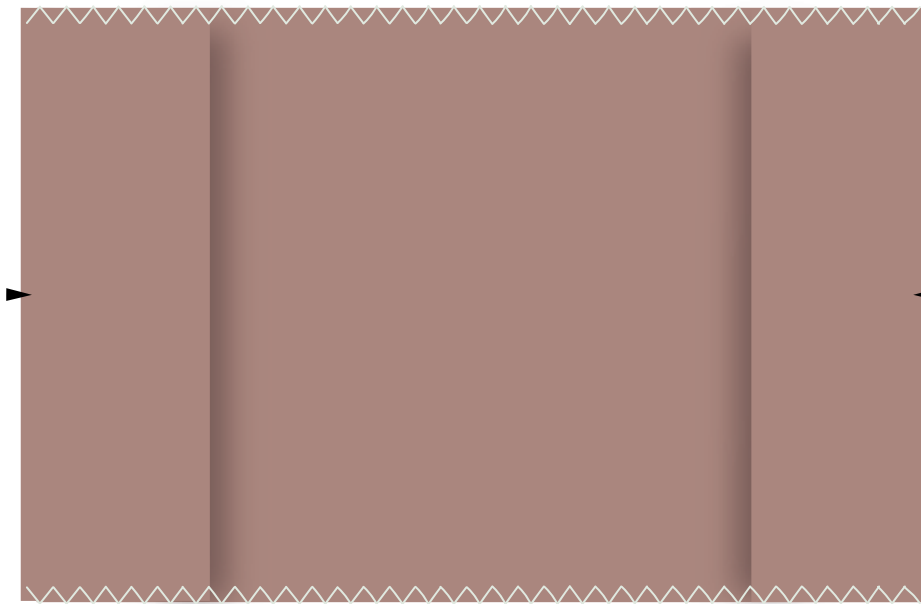

STEP 9

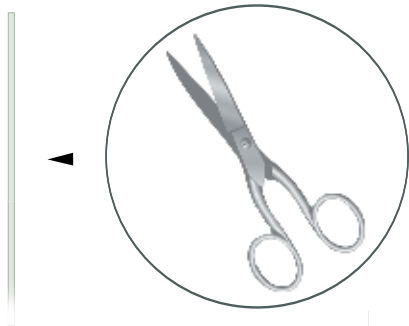

Repeat step 3:

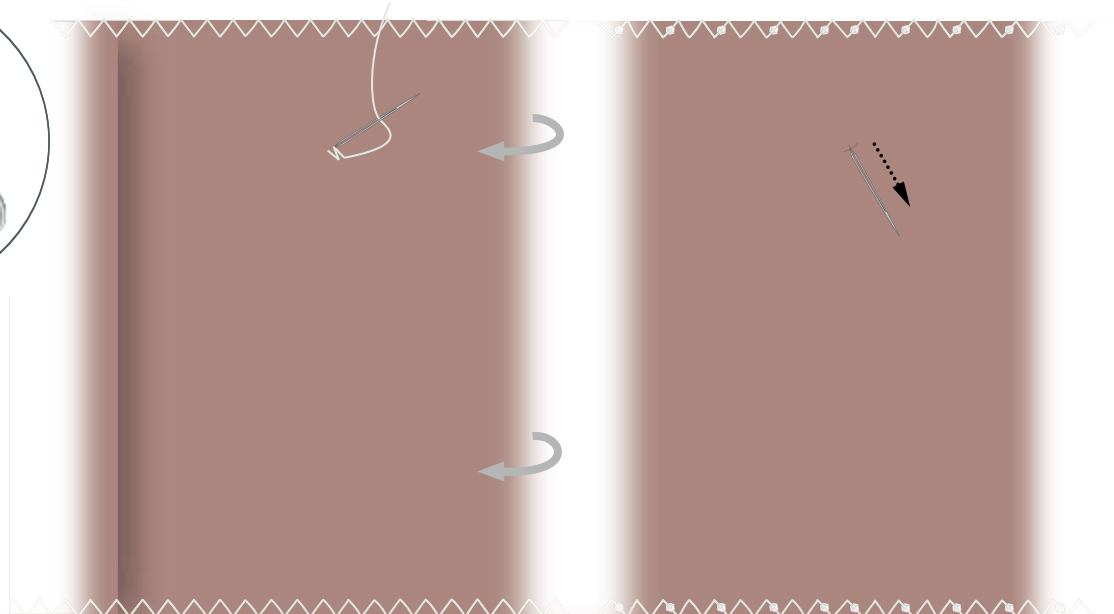

STEP 10

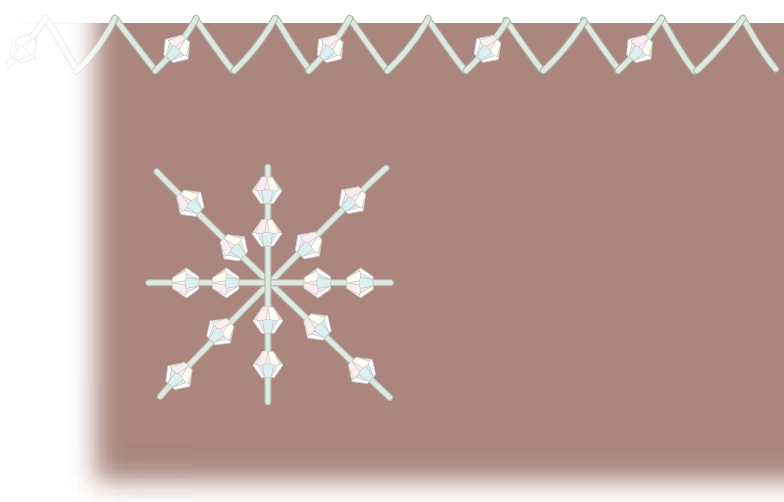
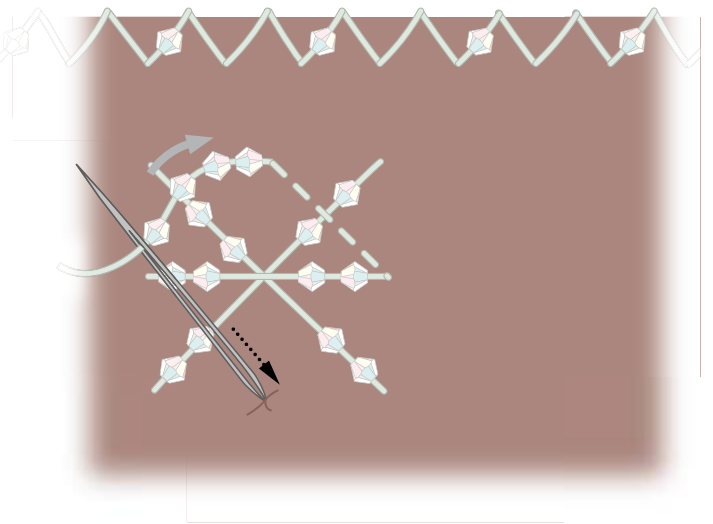
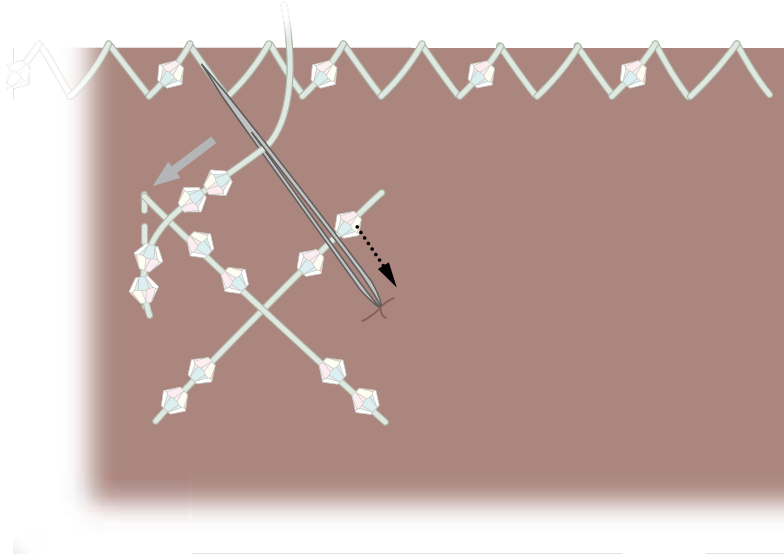
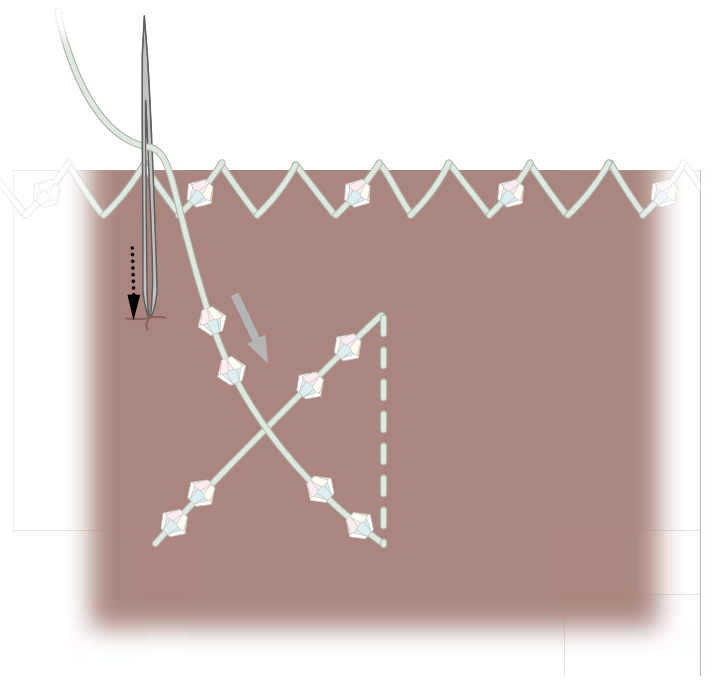
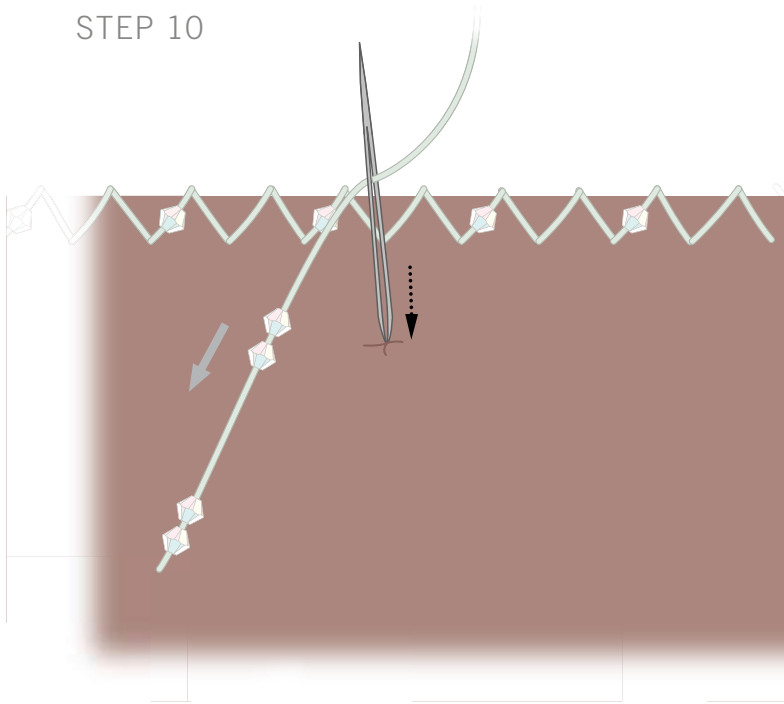

Scale 1:1

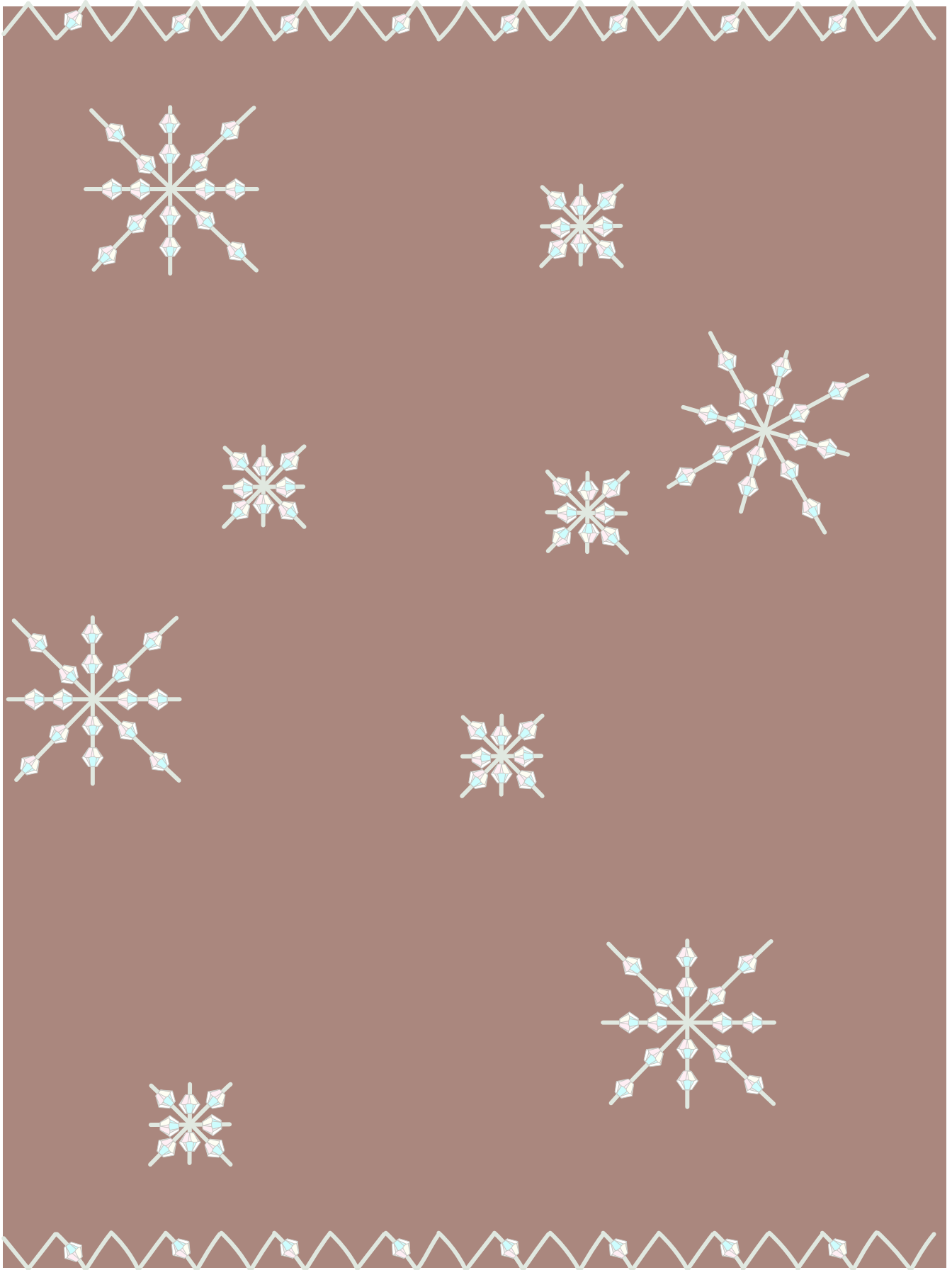

- STEP 1: Cut out a felt for the book cover according to the measurements as in step 1 in illustration. Placing the book on the felt cover, fold the cover inwards at both ends.
- STEP 2: The gap between the book and the edge of the cover should be around 6 mm. Fix it with pins like in picture in illustration. Pull out the book of the cover.
- STEP 3: As seen in the picture in illustration, sew some back stitches on to the corner with cream white yarn. The folded part should not be stitched over with these stitches; this would help in concealing the back stitches.
- STEP 4: After back stitches, cut off the short end of yarn and stitch to the front side as seen in the first picture in the illustration. Bring over the thread to the back side that is the folded side as seen in the second picture; you would stitch both of them together this time. Now repeat this to the other end having a gap of 1 cm between each stitch. Remove the sewing needle.
- STEP 5: Insert the beading needle as we would continue with the beading needle now. As seen in the second picture in illustration. Insert one CRYSTALLIZED™ Bead article 5328 4 mm in Crystal and move over to the backside and pierce back in through the front side from exactly the same place where the thread had pierced though earlier. Now again over to the backside and pierce in through to the front side but this time without adding the bead and from the very same point where the threads has earlier pierced in. Repeat this process until you reach though to the other end.
- STEP 6: Towards the end of the other side make some back stitches to secure the whole thing and then cut of the left over thread.
- STEP 7; Look at illustration; this is how it should look after the end of all the previous steps. Now repeat steps 4 - 6 for the other end of the book cover.
- STEP 8: Now iron the borders where the felt is folded inwards.
- STEP 9: Cut a piece of the cream white yarn and Repeat step 3 to make some back stitches at the back side of the cover and then stitch over to the front side.
- STEP 10: Look at illustration for stitching the star can be seen in the pictures in this step. You insert four CRYSTALLIZED™ Bead article 5328 for the bigger stars and two CRYSTALLIZED™ Bead for the smaller ones and then go in this criss-cross fashion, each time taking four or two more beads. Close each star with a few back stitches.