

CREATE
YOUR STYLE with
CRYSTALLIZED™
- Swarovski Elements



INSPIRATION GUIDE

THE BLISS OF A WINTER'S DAYDREAM

KEYPENDANT AND CASE CRYSTAL VALENTINE



CRYSTALLIZED™ – Swarovski Elements

Article	Product Group	Article No.
	Beads	5301
	Pendants	6202
	Pendants	6301

Instruction "Keypendant" enclosed



HEARTS FUNCTIONAL

You are sure to unlock your main squeeze's heart of hearts with this discreet, yet decidedly masculine sparkling key ring. Functional and sophisticated at the same time, the tonal lettering on the accompanying black case shimmers with just enough restraint to remind

him that in 2009, a man's got a right to shine! If flaunting his jewels just isn't his flavour of manhood, he may opt to use it as a shaving kit, for storing stationery, or for safekeeping your love letters to him – anything to keep its lustre present in his life!

VALENTINE KEYPENDANT



CRYSTALLIZED™ – Swarovski Elements

Article	Product Group	Article No.	Amount	Size	Colour	Colour Code
	Beads	5000	90 pcs.	3 mm	Jet Hematite	280 HEM
	Beads	5000	2 pcs.	6 mm	Light Siam	227
	Pendants	6202	2 pcs.	14 x 14.4 mm	Black Diamond	215

Supplies & Tools

Supplies

- 1 Carabiner, 4 x 2 cm, silver coloured
- Felt, 25 x 20 cm, red
- Leather, 25 x 20 cm, black
- Silk thread, 5 m, grey

Tools

- Cutter
- Double sided tape, 1 cm
- Needle
- Paper, A4
- Pencil
- Punching pliers
- Ruler
- Scissors
- Sewing machine
- Tape

STEP 1

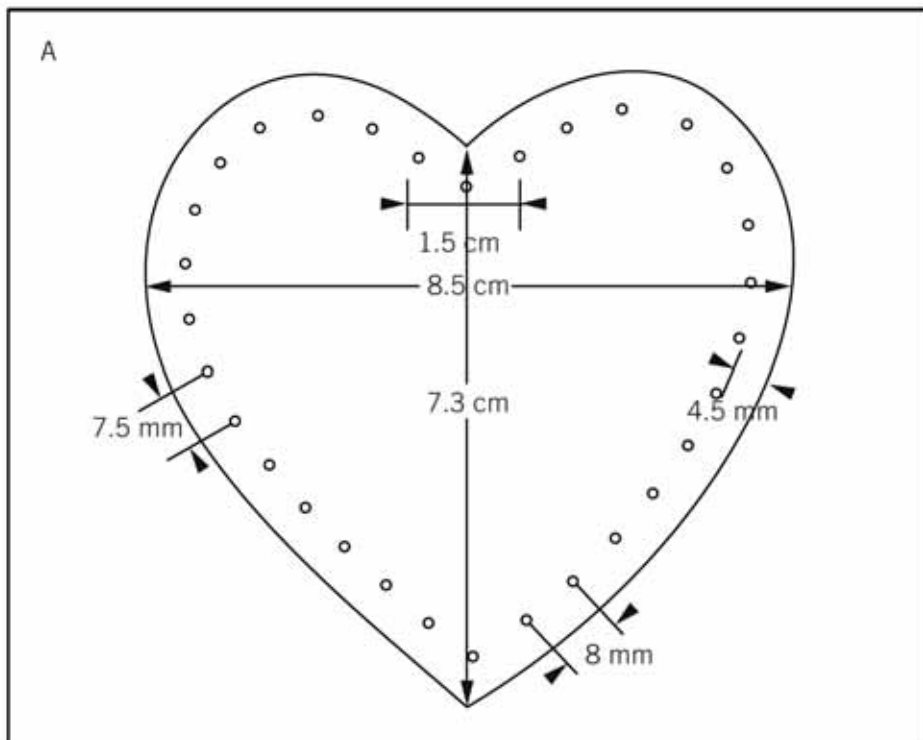

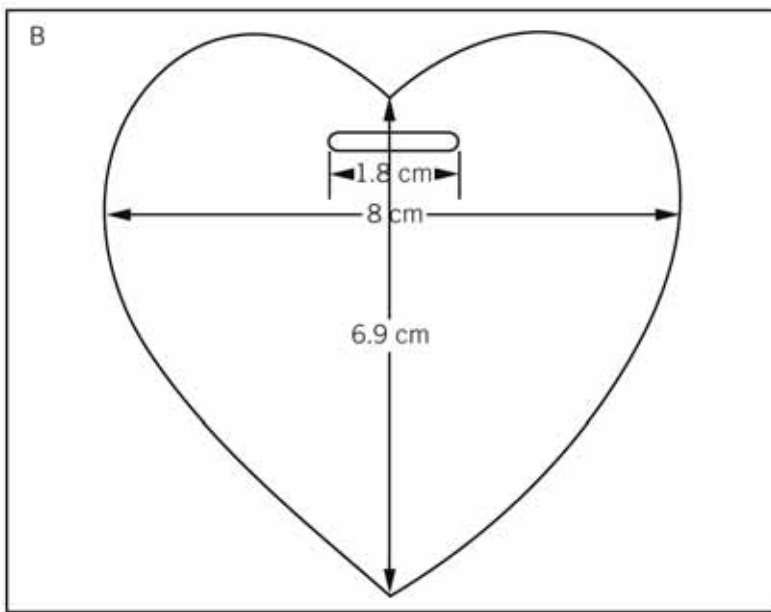
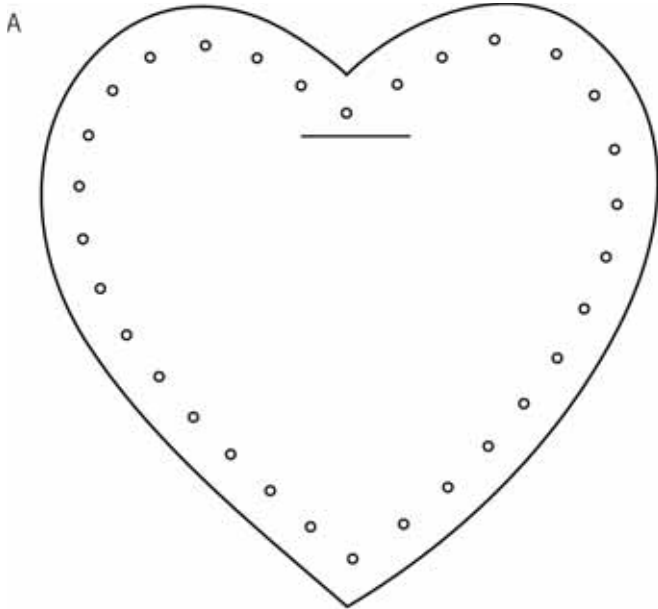

STEP 2

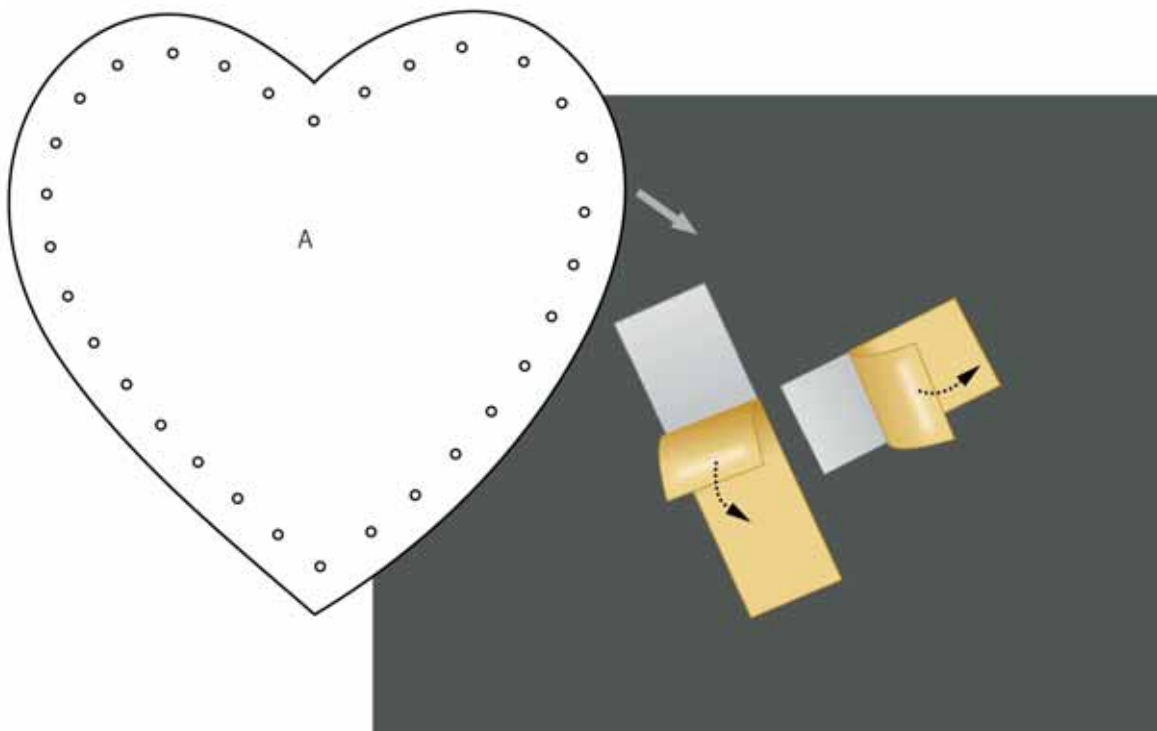

STEP 3

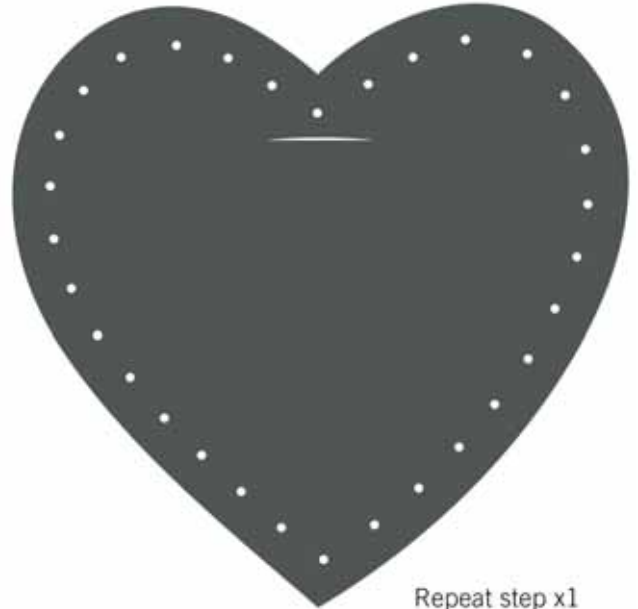
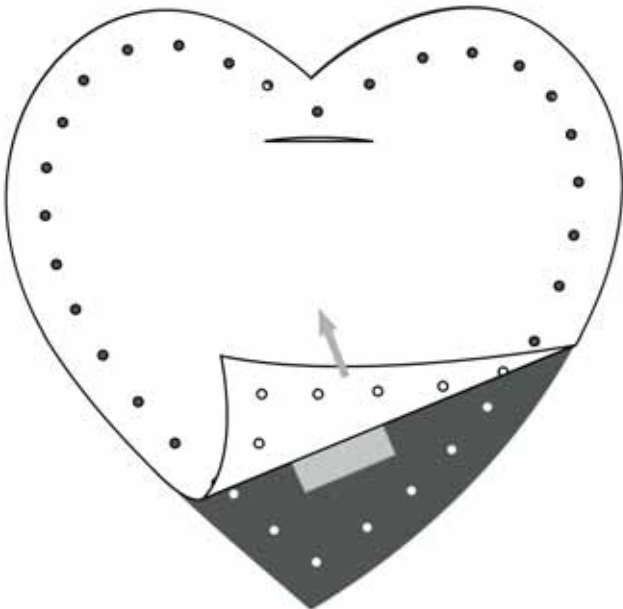
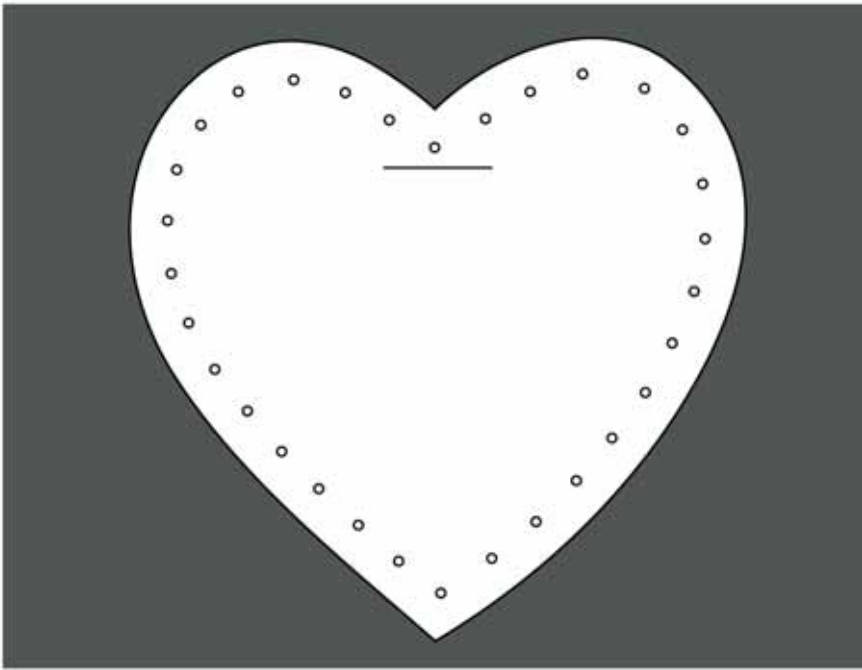

Repeat step x1

STEP 4

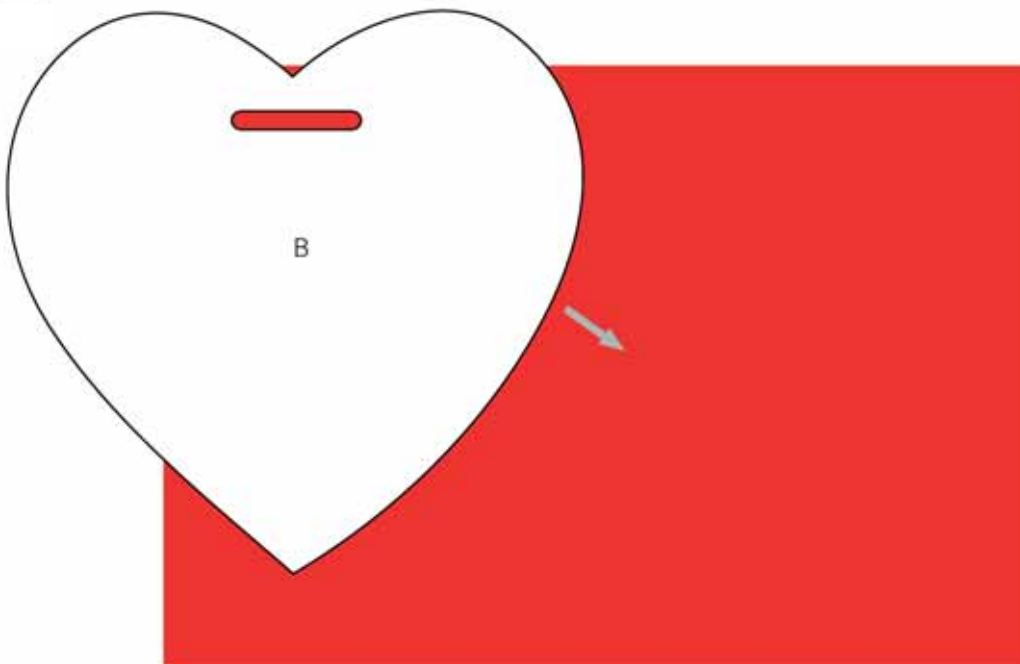

Repeat step x1

STEP 5

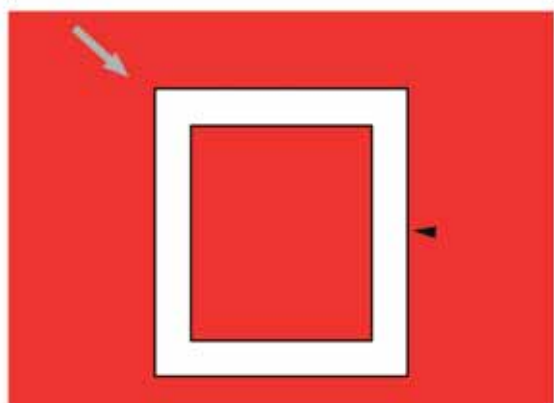
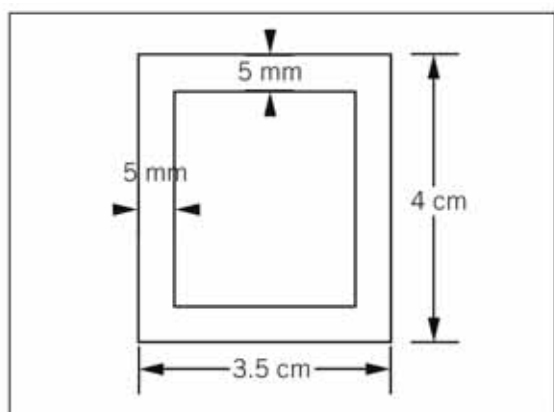

STEP 6

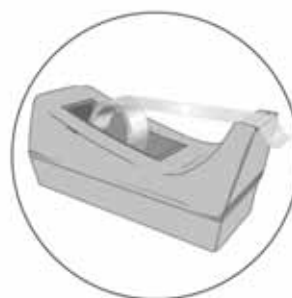
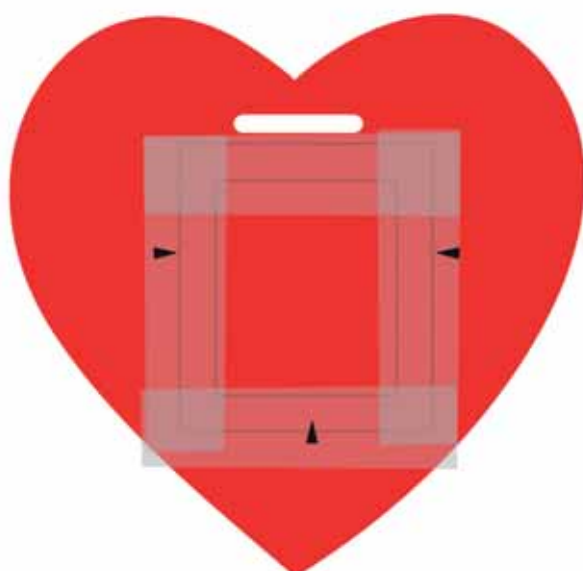
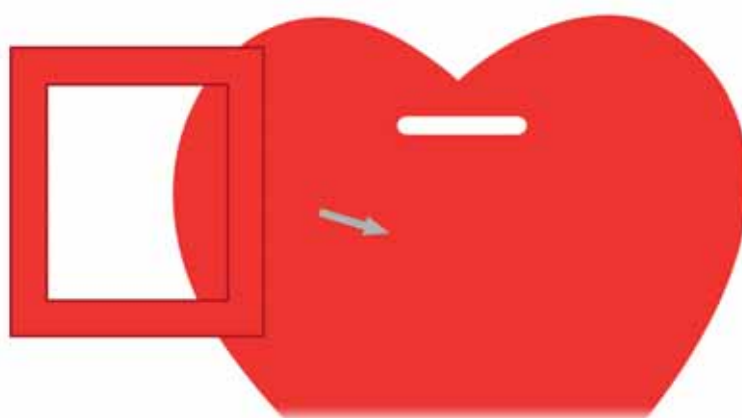

STEP 7

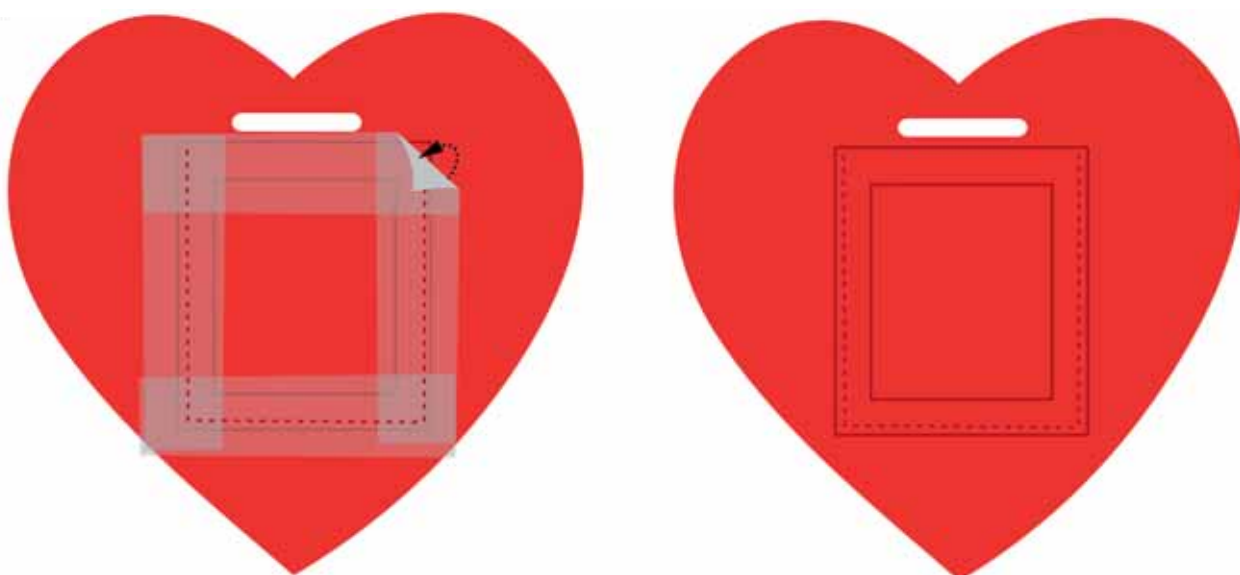

STEP 8

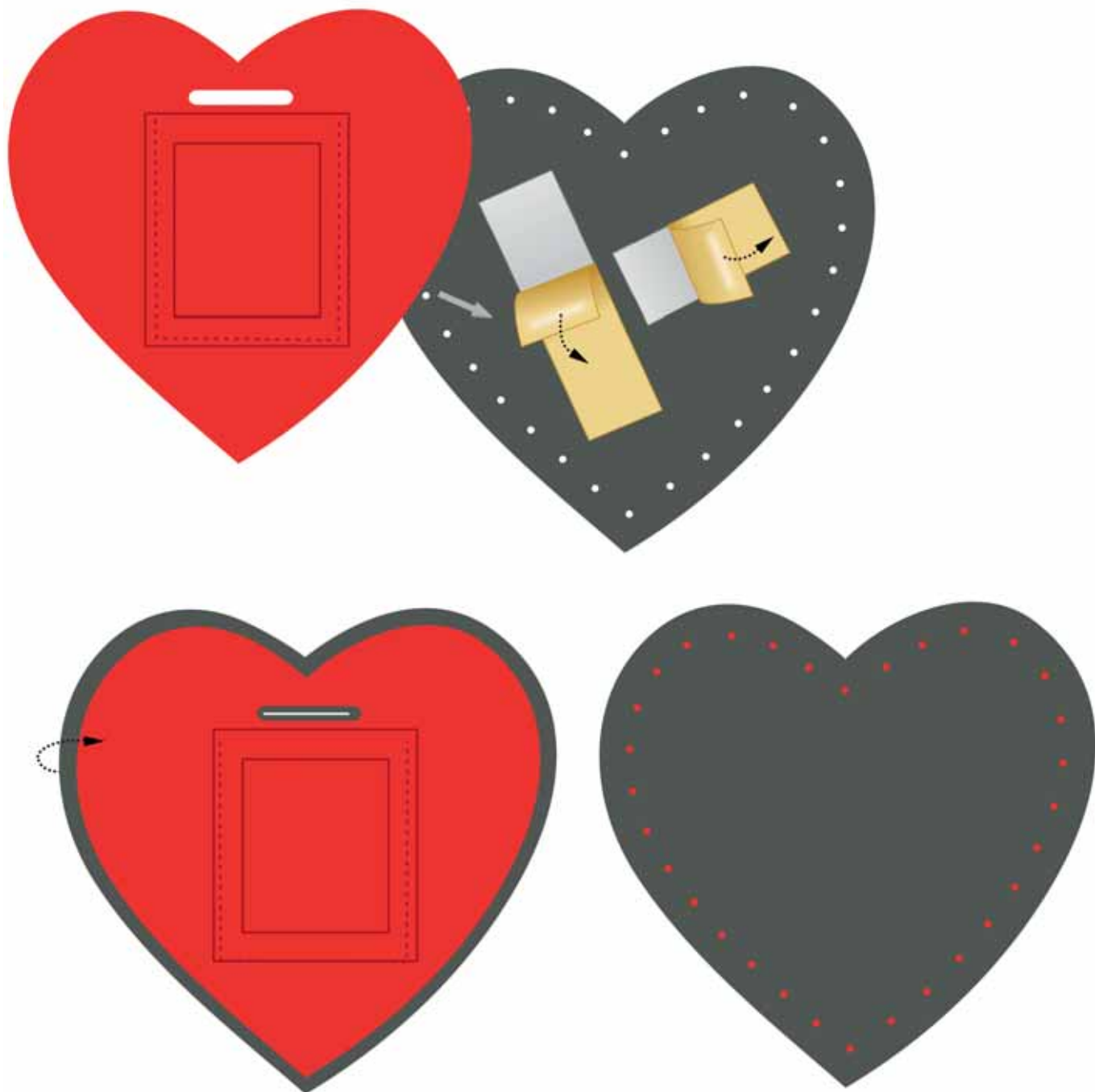

STEP 9

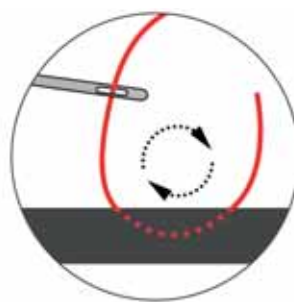
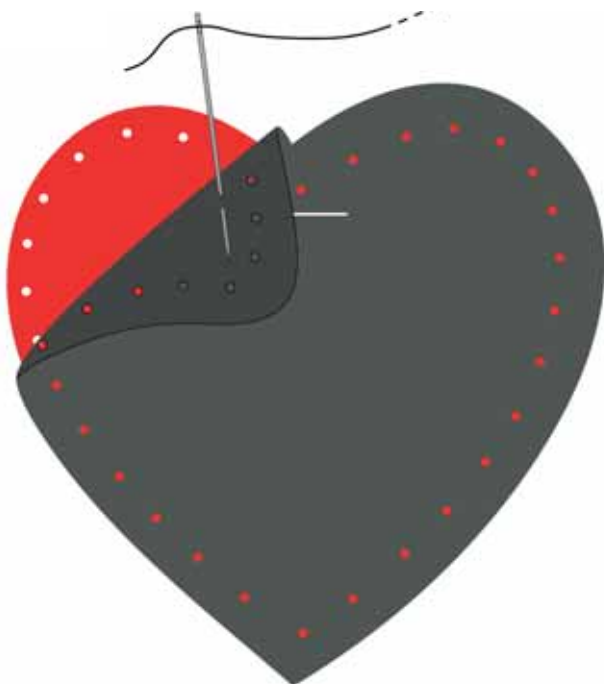

x4

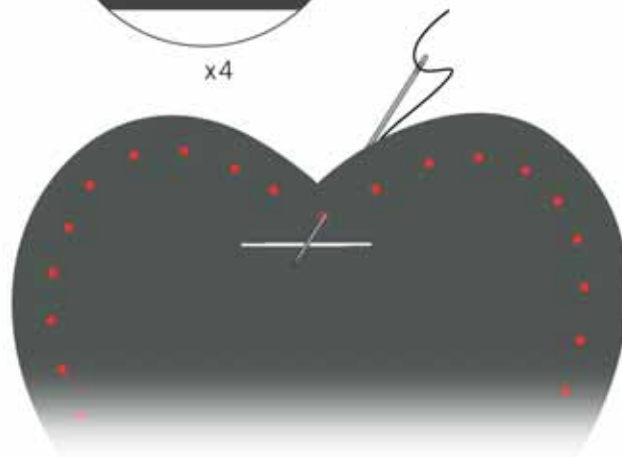

STEP 10

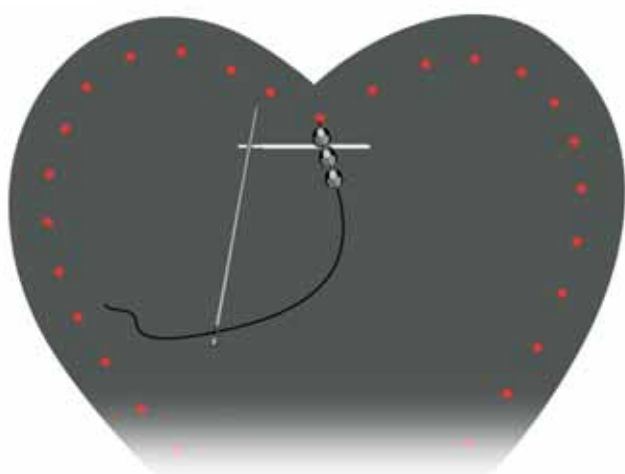

Repeat x7

STEP 11

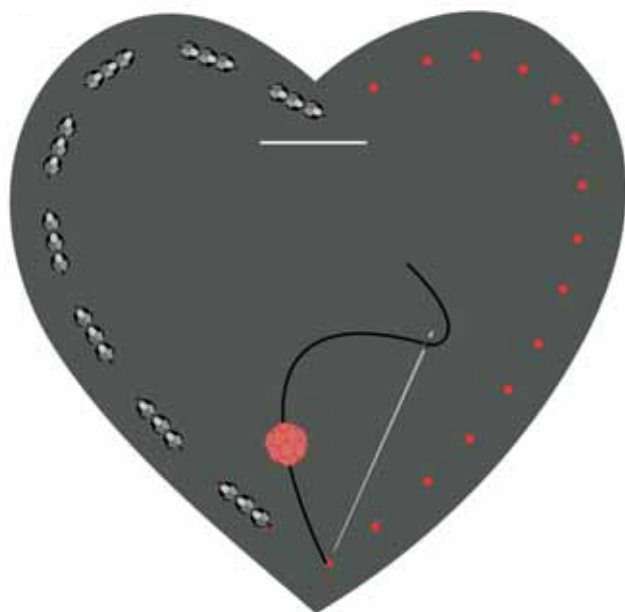

STEP 12

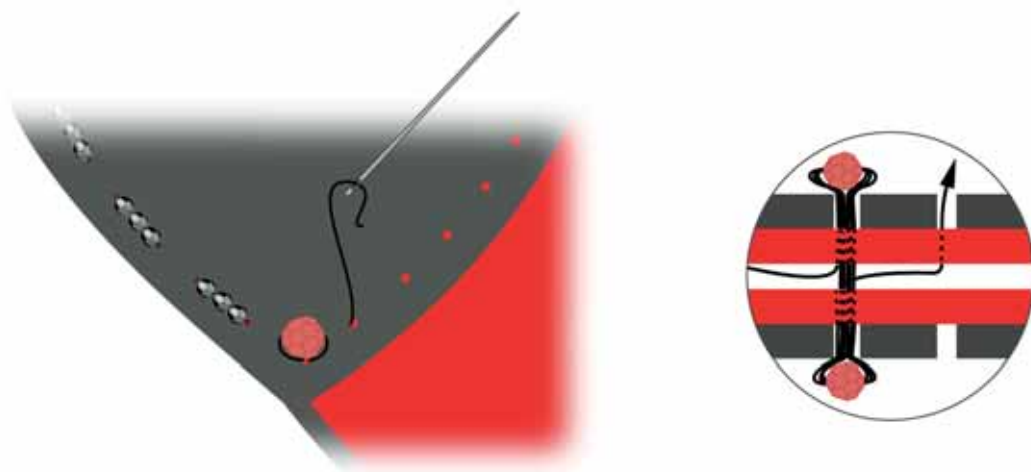
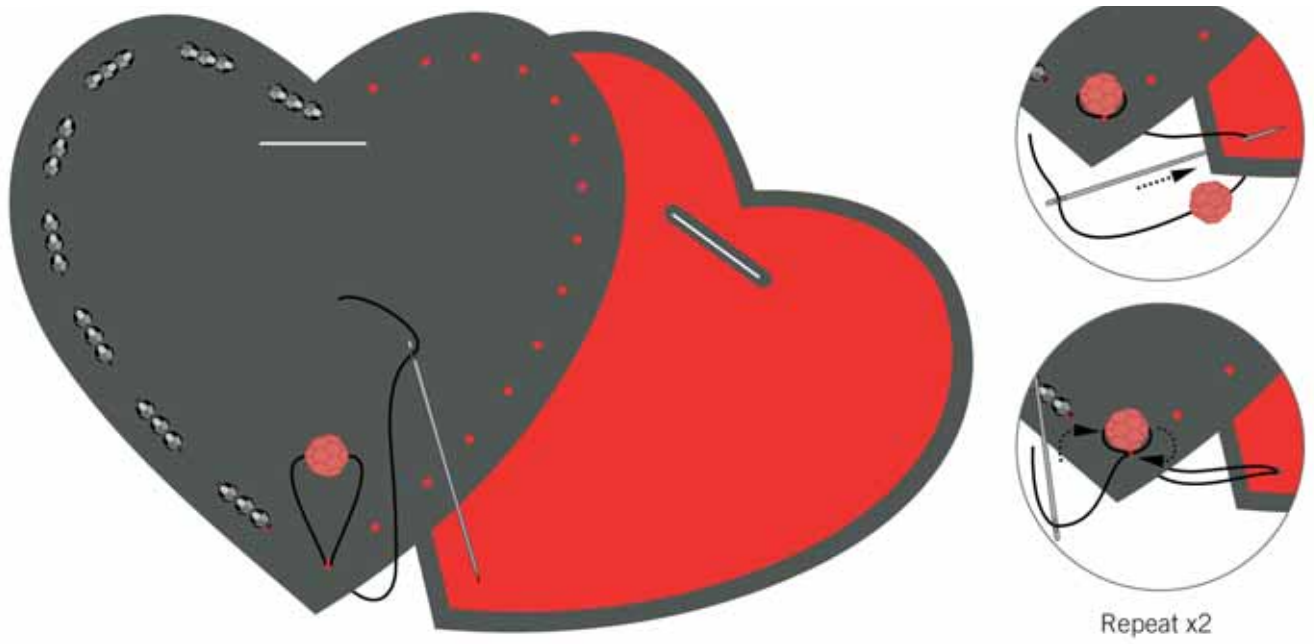

STEP 13

Repeat step 10 x7

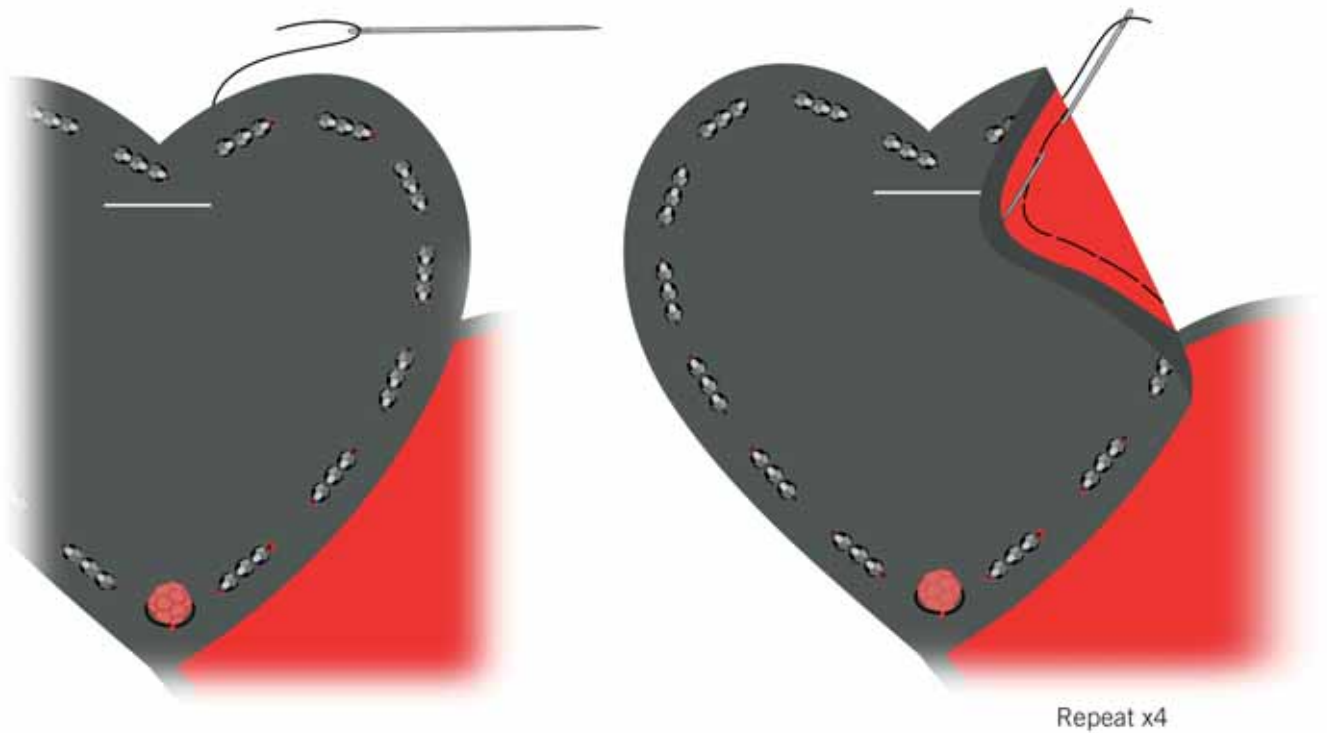

STEP 14

Repeat steps 10 + 13

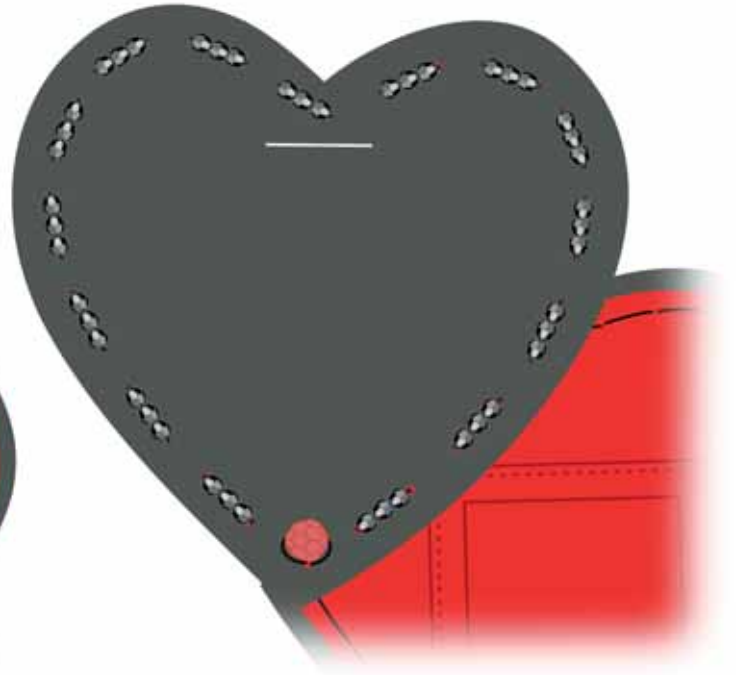
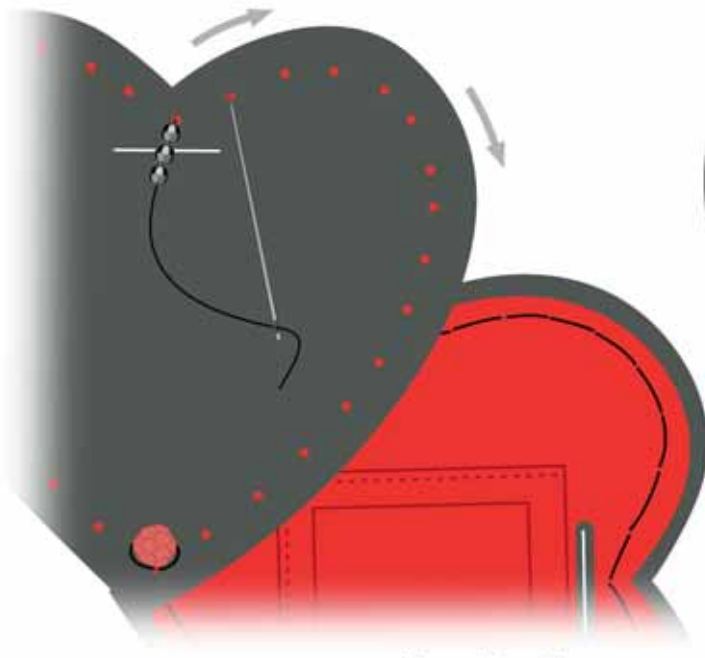

Repeat step 7

STEP 15



STEP 16

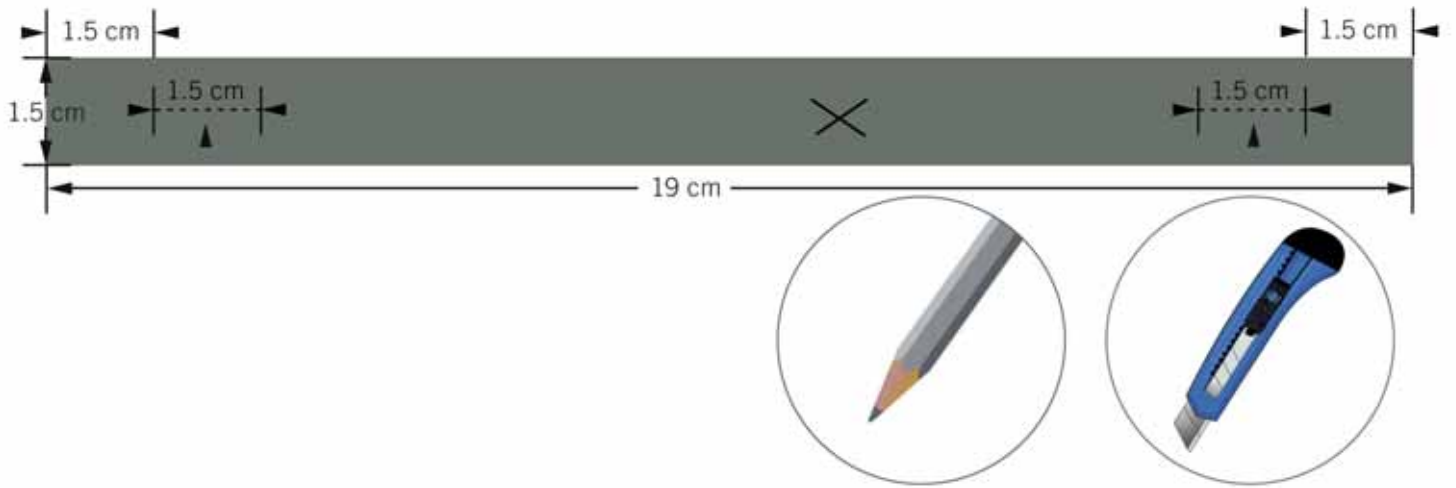

STEP 17

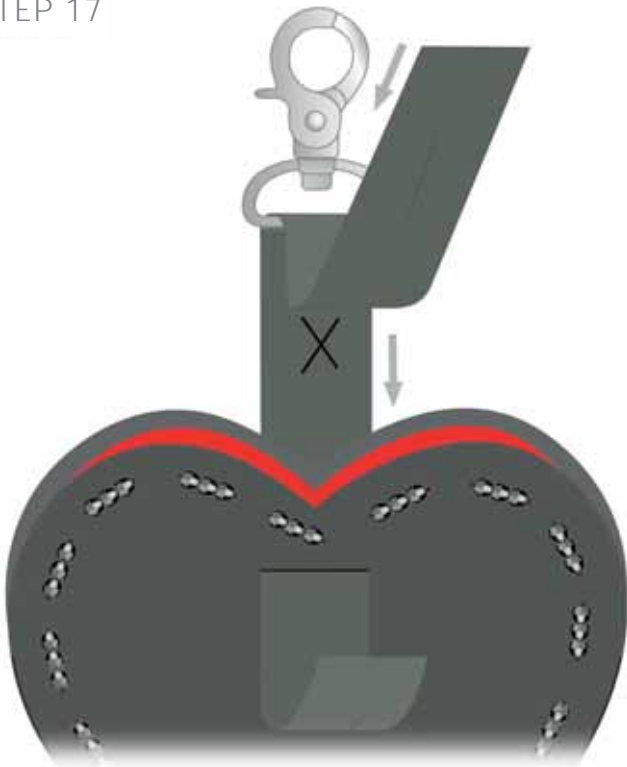

STEP 18

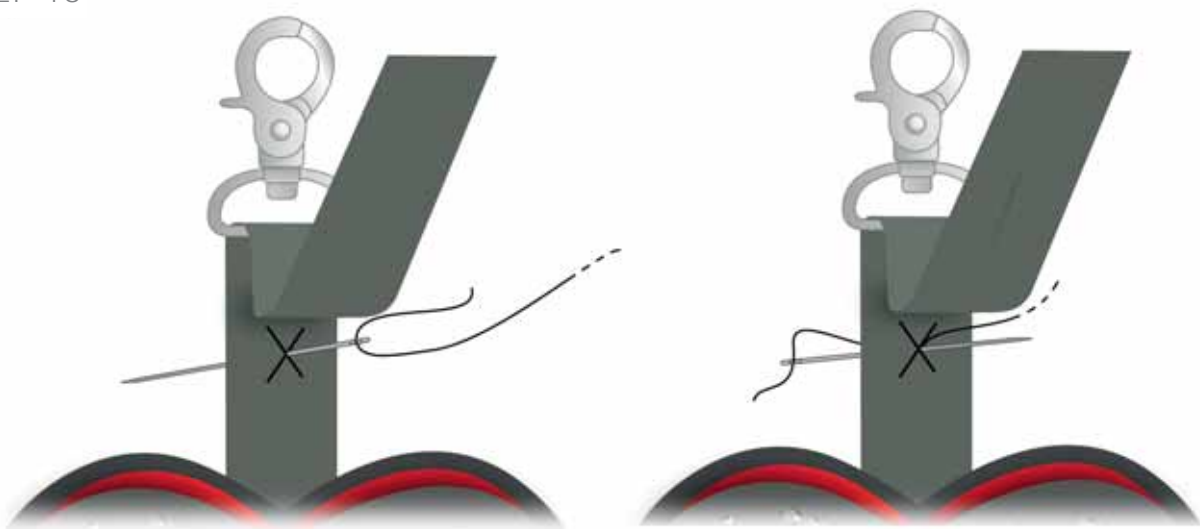

Repeat x4

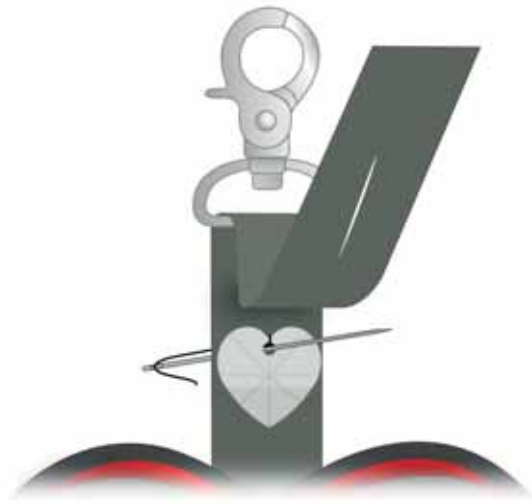
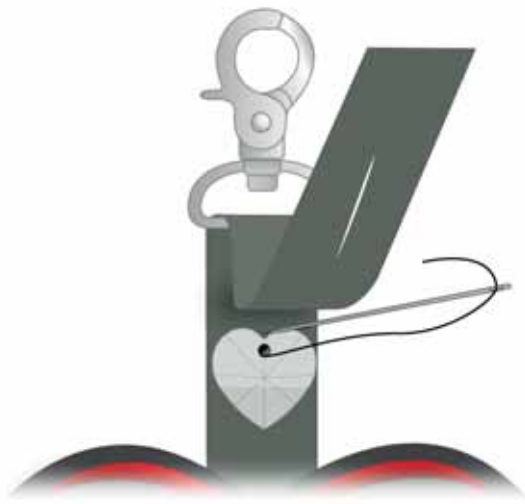

Repeat x4

STEP 19

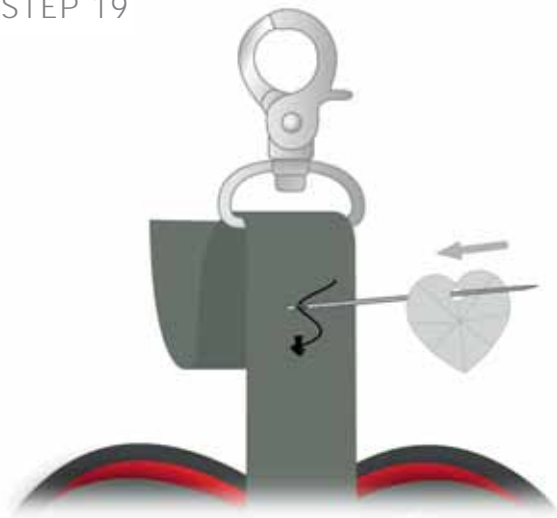

Repeat step 18



STEP 20

